

Essential Components Catalog



Circuit Protection

Air Circuit Breakers	A
Molded Case Circuit Breakers	B
Molded Case Switches	C
Motor Circuit Protectors	D
Enclosed Breakers	E
Miniature Circuit Breakers	F
Surge Protective Devices	G
Fuse Holders	H

Industrial Control

Manual Motor Starters	I
Contactors	J
Overloads	K
Safety Contactors	L
Safety Control Relays	M
Soft Starters	N
Indicator Lights	O
Push Buttons & Selector Switches	P

Appendix

Appendix A: UL 489 and UL 60947-4-1 Applications	Q
Appendix B: Short Circuit Current Rating Tables	Q
Appendix C: Terms and Condition of Sale	Q

Company Overview

About us

NOARK Electric is a global manufacturer of low-voltage electrical components for industrial applications. We specialize in motor controls and circuit protection for original equipment manufacturers. Our mission is to provide customers with the highest quality products at an exceptional value and back them with world-class service and support. Every NOARK product is tested and certified to the highest industry standards.

Research and Development

The entire portfolio of high-quality NOARK products is designed for manufacturing and assembly. Each component is developed in-house by our engineering team to meet the strictest standards and performance requirements. This dedication to excellence has led to the development of patented technology found in many of our products.

World-class Manufacturing

After being thoroughly tested, approved and certified – each NOARK product is sent into production at our state-of-the-art manufacturing facilities. This allows us to maintain strict quality control standards throughout the manufacturing process. In addition, NOARK Electric adheres to a policy of environmental protection and sustainability.

North American Distribution

NOARK's distribution centers are located in Pomona, CA and Kitchener, ON, with the aim of ensuring prompt and reliable deliveries of the entire product range to our customers all over North America. Our supply chain team works closely with our factories and logistics partners to ensure the availability of our products on the North American market and provide logistics services on the level which our customers expect.

NOARK Electric is a wholly subsidiary of the largest electrical manufacturing group in Asia with over 50 thousand employees and sales revenue of \$22 billion USD. We have corporate facilities in Los Angeles, Shanghai and Prague to service the requirements of individual markets and countries.

140+ Countries
300+ Overseas Distributors
20 Overseas Subsidiaries
22 Logistics Centers
3 R & D Centers
10,000,000+ Sq.Ft. Manufacturing Space
50,000+ Employees Worldwide



Table of Contents

Circuit Protection

Power Circuit Breaker - Series A25.....	4
Technical Data.....	6
Power Circuit Breaker - Series A32.....	7
Technical Data.....	9
Power Circuit Breaker - Series A40.....	10
Technical Data.....	12
Molded Case Circuit Breakers (MCCB) - UL 489 Branch Circuits	13
Technical Data.....	19
Molded Case Switches (MCS) - UL 489	21
Technical Data.....	23
Motor Circuit Protectors (MCP).....	24
Technical Data.....	26
MCCB/MCS/MCP Accessories	28
Enclosed Breakers	40
Miniature Circuit Breakers (MCB) - UL 489 Branch Circuits	43
Technical Data.....	52
Accessories	53
Supplementary Protector MCB - UL 1077	55
Technical Data.....	58
Accessories	59
Surge Protective Devices.....	61
Technical Data.....	63
F30 Series Fuse Holder - UL4248-1-4-19	64
Technical Data.....	66

Industrial Control

Manual Motor Starters - UL 60947-4-1 (formerly UL 508)	67
Technical Data.....	69
Accessories	73
IEC Mini Contactors - UL 508, 60947-4-1.....	75
Technical Data.....	77
Accessories	79
IEC Standard Contactors - UL 508, 60947-4-1	80
Technical Data.....	83
Accessories	88
Overload Relays - For Mini and Standard Contactors	91
Safety Contactors - UL 60947-5-1 Safety function applications	97
Technical Data.....	99
Safety Control Relays - UL 60947-5-1 Safety function applications.....	101
Technical Data.....	103
Soft Starter	104
Technical Data.....	106
Indicator Lights.....	108
Pushbuttons & Selector Switches	110

Appendix

Appendix A: UL 489 and UL 60947-4-1 (formerly UL 508) Applications	118
Appendix B: Short Circuit Current Rating Tables	119
Appendix C: Terms and Condition of Sale	125

A25 Series Power Circuit Breaker

Product Overview

Features

NOARK Electric A25 products are optimized for OEMs and are manufactured under world-class quality systems in our ISO accredited factories. Like all NOARK products, these breakers are designed to deliver high quality, superior performance, and outstanding value. A25 Power Circuit Breakers are available up to 2500A and are capable of IC ratings up to 85kA at 847 Volts. UL Listed and CSA Certified, the A25 family of products provide design standardization for OEM's no matter where they do business. A25 breakers offer a broad range of available trip units, accessories, and communications options. They are the ideal OEM solution for low voltage switchgear and customized power distribution assemblies used in Data Centers, Standby Power, Industrial, Healthcare and Commercial applications.

- 600A through 2500A
- IC ratings up to 85kA at 847Vac
- Short-Time Withstand, 85kA at 847Vac
- 50 or 60Hz operation
- 3-pole and 4-pole designs



Accessories

- Trip Unit - LI, LSI, LSIg
- Electrical: Auxiliary Contacts, Motor Operator, Shunt Release, Undervoltage Release, Closing Release, Position Indicator, Ready-to-Close signal contact, Neutral Current Sensor, Rear Terminal Connectors, Energy-limiting maintenance switch.
- Mechanical: Pushbutton Locking Cover, Door Frame, Phase Barrier, Mechanical Interlocking with cables, Door Interlock.

Certifications

- UL 1066, Low-Voltage AC and Circuit Breakers
- CSA C22.2 No. 31
- ANSI C37.13 Low Voltage Power Circuit Breakers
- ANSI C37.16 Low Voltage Power Circuit Breakers Ratings, Related Requirements and Applications



QR code to download A25 Catalog



QR code to product Website



A25 Series Power Circuit Breaker

Product Selection

Product Family	Number of Poles	Frame Type	Connection Type	Rated Current (A)	Q-Interrupting 65kA @ 800Vac		R-Interrupting 75kA @ 800Vac		H-Interrupting 85kA @ 800Vac	
					Catalog Number	Part Number	Catalog Number	Part Number	Catalog Number	Part Number
A25	3	Fixed	Horizontal	600	A25Q3FH600	1800577	A25R3FH600	1800619	A25H3FH600	1800661
				800	A25Q3FH800	1800578	A25R3FH800	1800620	A25H3FH800	1800662
				1200	A25Q3FH1200	1800579	A25R3FH1200	1800621	A25H3FH1200	1800663
				1600	A25Q3FH1600	1800580	A25R3FH1600	1800622	A25H3FH1600	1800664
				2000	A25Q3FH2000	1800581	A25R3FH2000	1800623	A25H3FH2000	1800665
			Vertical	600	A25Q3FV600	1800582	A25R3FV600	1800624	A25H3FV600	1800666
				800	A25Q3FV800	1800583	A25R3FV800	1800625	A25H3FV800	1800667
				1200	A25Q3FV1200	1800584	A25R3FV1200	1800626	A25H3FV1200	1800668
				1600	A25Q3FV1600	1800585	A25R3FV1600	1800627	A25H3FV1600	1800669
				2000	A25Q3FV2000	1800586	A25R3FV2000	1800628	A25H3FV2000	1800670
		Drrawout	Horizontal	600	A25Q3DH600	1800599	A25R3DH600	1800641	A25H3DH600	1800683
				800	A25Q3DH800	1800600	A25R3DH800	1800642	A25H3DH800	1800684
				1200	A25Q3DH1200	1800601	A25R3DH1200	1800643	A25H3DH1200	1800685
				1600	A25Q3DH1600	1800602	A25R3DH1600	1800644	A25H3DH1600	1800686
				2000	A25Q3DH2000	1800603	A25R3DH2000	1800645	A25H3DH2000	1800687
			Vertical	600	A25Q3DV600	1800604	A25R3DV600	1800646	A25H3DV600	1800688
				800	A25Q3DV800	1800605	A25R3DV800	1800647	A25H3DV800	1800689
				1200	A25Q3DV1200	1800606	A25R3DV1200	1800648	A25H3DV1200	1800690
				1600	A25Q3DV1600	1800607	A25R3DV1600	1800649	A25H3DV1600	1800691
				2000	A25Q3DV2000	1800608	A25R3DV2000	1800650	A25H3DV2000	1800692

A

Product Family	Number of Poles	Frame Type	Connection Type	Rated Current (A)	Q-Withstand Rating 65kA @ 800Vac		R-Withstand Rating 75kA @ 800Vac		H-Withstand Rating 85kA @ 800Vac	
					Catalog Number	Part Number	Catalog Number	Part Number	Catalog Number	Part Number
ASD25 Disconnect Switch	3	Fixed	Horizontal	600	ASD25Q3FH600	1800703	ASD25R3FH600	1800745	ASD25H3FH600	1800787
				800	ASD25Q3FH800	1800704	ASD25R3FH800	1800746	ASD25H3FH800	1800788
				1200	ASD25Q3FH1200	1800705	ASD25R3FH1200	1800747	ASD25H3FH1200	1800789
				1600	ASD25Q3FH1600	1800706	ASD25R3FH1600	1800748	ASD25H3FH1600	1800790
				2000	ASD25Q3FH2000	1800707	ASD25R3FH2000	1800749	ASD25H3FH2000	1800791
			Vertical	600	ASD25Q3FV600	1800708	ASD25R3FV600	1800750	ASD25H3FV600	1800792
				800	ASD25Q3FV800	1800709	ASD25R3FV800	1800751	ASD25H3FV800	1800793
				1200	ASD25Q3FV1200	1800710	ASD25R3FV1200	1800752	ASD25H3FV1200	1800794
				1600	ASD25Q3FV1600	1800711	ASD25R3FV1600	1800753	ASD25H3FV1600	1800795
				2000	ASD25Q3FV2000	1800712	ASD25R3FV2000	1800754	ASD25H3FV2000	1800796
		Drrawout	Horizontal	600	ASD25Q3DH600	1800725	ASD25R3DH600	1800767	ASD25H3DH600	1800809
				800	ASD25Q3DH800	1800726	ASD25R3DH800	1800768	ASD25H3DH800	1800810
				1200	ASD25Q3DH1200	1800727	ASD25R3DH1200	1800769	ASD25H3DH1200	1800811
				1600	ASD25Q3DH1600	1800728	ASD25R3DH1600	1800770	ASD25H3DH1600	1800812
				2000	ASD25Q3DH2000	1800729	ASD25R3DH2000	1800771	ASD25H3DH2000	1800813
			Vertical	600	ASD25Q3DV600	1800730	ASD25R3DV600	1800772	ASD25H3DV600	1800814
				800	ASD25Q3DV800	1800731	ASD25R3DV800	1800773	ASD25H3DV800	1800815
				1200	ASD25Q3DV1200	1800732	ASD25R3DV1200	1800774	ASD25H3DV1200	1800816
				1600	ASD25Q3DV1600	1800733	ASD25R3DV1600	1800775	ASD25H3DV1600	1800817
				2000	ASD25Q3DV2000	1800734	ASD25R3DV2000	1800776	ASD25H3DV2000	1800818

A25 Series Power Circuit Breaker

Technical Specifications

A25 Series Power Circuit Breakers			A25Q	A25R	A25H
Poles			3 Poles 4 Poles		
Mounting Type			Fixed Drawout		
Rated current (A)	Fixed		600 800 1200 1600 2000 2500		
	Drawout		600 800 1200 1600 2000		
Rated Maximum Voltage Vac			254 508 635 847		
Frequency (Hz)			50 60		
Interrupting rating at rated maximum voltage (kA)	254Vac		65	85	100
	508Vac		65	85	100
	635Vac		65	75	85
	847Vac		65	75	85
Short time withstand current (kA)	254Vac		65	75	85
	508Vac		65	75	85
	635Vac		65	75	85
	847Vac		65	75	85
Operating time (ms)	Open		≤30		
	Close		≤70		
Life cycle (time)	Mechanical	Without maintenance	10000		
	Electrical	Without maintenance 635Vac	600		
	Electrical	Without maintenance 847Vac	300		

A25 Series Power Circuit Breakers			ASD25Q	ASD25R	ASD25H
Poles			3 Poles 4 Poles		
Mounting Type			Fixed Drawout		
Rated current (A)	Fixed		600 800 1200 1600 2000 2500		
	Drawout		600 800 1200 1600 2000		
Rated Maximum Voltage (Vac)			254 508 635 847		
Frequency (Hz)			50 60		
Short time withstand current (kA)	254 (Vac)		65	75	85
	508 (Vac)		65	75	85
	635 (Vac)		65	75	85
	847 (Vac)		65	75	85
Operating time (ms)	Open		≤30		
	Close		≤70		
Life cycle (time)	Mechanical	Without maintenance	10000		
	Electrical	Without maintenance 635 (Vac)	600		
	Electrical	Without maintenance 847 (Vac)	300		

Overall Dimensions			Height	Width	Depth
HxWxD (in/mm)	Drawout	3 Poles	18.11 (460)	14.06 (357)	16.93 (430)
		4 Poles	18.113 (460)	17.80 (452)	16.93 (430)
	Fixed	3 Poles	14.49 (368)	12.52 (318)	12.05 (306)
		4 Poles	14.49 (368)	16.26 (413)	12.05 (306)
Enclosure dimensions HxWxD (in/mm)	Drawout	3 Poles	20.87 (530) Ventilation Area Top: 0mm² Bottom: 0mm²	17.72 (450)	18.31 (465)
		4 Poles	20.87 (530) Ventilation Area Top: 0mm² Bottom: 0mm²	21.46 (545)	18.31 (465)

Weight lb (kg)		Fixed	Drawout
Power Circuit Breakers - A25	3 Poles 600A~1200A	104 (47)	194 (88)
	3 Poles 1600A~2000A	106 (48)	200 (91)
	3 Poles 2500A	119 (54)	/
Non-Automatic Switches - ASD25	3 Poles 600A~1200A	97 (44)	187 (85)
	3 Poles 1600A~2000A	101 (46)	194 (88)
	3 Poles 2500A	112 (51)	/

A32 Series Power Circuit Breaker

Product Overview

Features

NOARK Electric is proud to offer its A32 family of Power Circuit Breakers, Non-Automatic Disconnect Switches, and accessories. Our A32 products are optimized for OEMs and are manufactured under world-class quality systems in our ISO accredited factories. Like all NOARK products, these breakers are designed to deliver high quality, superior performance, and outstanding value.

A32 Power Circuit Breakers are available up to 3200A and are capable of IC ratings up to 100kA at 635 Volts. UL Listed and CSA Certified, the A32 family of products provide design standardization for OEM's no matter where they do business. A32 breakers offer a broad range of available trip units, accessories, and communications options. They are the ideal OEM solution for low voltage switchgear and customized power distribution assemblies used in Data Centers, Standby Power, Industrial, Healthcare and Commercial applications.

- 800A through 3200A
- IC ratings up to 100kA at 635Vac
- Short-Time Withstand, 100kA at 635Vac
- 50 or 60Hz operation
- 3-pole and 4-pole designs

Accessories

- Trip Unit: LI, LSI, LSIG
- Electrical: Auxiliary Contacts, Motor Operator, Shunt Release, Undervoltage Release, Closing Release, Position Indicator, Ready-to-Close signal contact, Neutral Current Sensor, Voltage Conversion Module, Rear Terminal Connectors, Energy-limiting maintenance switch.
- Mechanical: Locking Provision, Door Frame, Phase Barrier, Mechanical Interlocking with cables, Door Interlock.

Certifications

- UL 1066, Low-Voltage AC Power Circuit Breakers
- CSA C22.2 No. 31
- ANSI C37.13 Low Voltage Power Circuit Breakers
- ANSI C37.16 Low Voltage Power Circuit Breakers Ratings, Related Requirements and Applications



A



QR code to
download A32
Catalog



QR code to product
Website



A32 Series Power Circuit Breaker

Product Selection

Product Family	Number of Poles	Frame Type	Connection Type	Rated Current (A)	Q Interrupting 65kA @ 600Vac		R Interrupting 85kA @ 600Vac		H Interrupting 100kA @ 600Vac	
					Catalog Number	Part Number	Catalog Number	Part Number	Catalog Number	Part Number
A32 Breaker	3	Fixed	Horizontal	800	A32Q3FH800	1800000	A32R3FH800	1800034	A32H3FH800	1800068
				1600	A32Q3FH1600	1800001	A32R3FH1600	1800035	A32H3FH1600	1800069
				2000	A32Q3FH2000	1800002	A32R3FH2000	1800036	A32H3FH2000	1800070
				2500	A32Q3FH2500	1800003	A32R3FH2500	1800037	A32H3FH2500	1800071
			Vertical	800	A32Q3FV800	1800004	A32R3FV800	1800038	A32H3FV800	1800072
				1600	A32Q3FV1600	1800005	A32R3FV1600	1800039	A32H3FV1600	1800073
				2000	A32Q3FV2000	1800006	A32R3FV2000	1800040	A32H3FV2000	1800074
				2500	A32Q3FV2500	1800007	A32R3FV2500	1800041	A32H3FV2500	1800075
		Drawout	Horizontal	3200	A32Q3FV3200	1800450	A32R3FV3200	1800451	A32H3FV3200	1800452
				800	A32Q3DH800	1800008	A32R3DH800	1800042	A32H3DH800	1800076
				1600	A32Q3DH1600	1800009	A32R3DH1600	1800043	A32H3DH1600	1800077
				2000	A32Q3DH2000	1800010	A32R3DH2000	1800044	A32H3DH2000	1800078
			Vertical	2500	A32Q3DH2500	1800011	A32R3DH2500	1800045	A32H3DH2500	1800079
				800	A32Q3DV800	1800012	A32R3DV800	1800046	A32H3DV800	1800080
				1600	A32Q3DV1600	1800013	A32R3DV1600	1800047	A32H3DV1600	1800081
				2000	A32Q3DV2000	1800014	A32R3DV2000	1800048	A32H3DV2000	1800082
2500	A32Q3DV2500	1800015	A32R3DV2500	1800049	A32H3DV2500	1800083				
3200	A32Q3DV3200	1800016	A32R3DV3200	1800050	A32H3DV3200	1800084				

Product Family	Number of Poles	Frame Type	Connection Type	Rated Current (A)	Q - Withstand Rating 65kA @ 600Vac		R - Withstand Rating 85kA @ 600Vac		H - Withstand Rating 100kA @ 600Vac	
					Catalog Number	Part Number	Catalog Number	Part Number	Catalog Number	Part Number
ASD32 Disconnect Switch	3	Fixed	Horizontal	800	ASD32Q3FH800	1800102	ASD32R3FH800	1800136	ASD32H3FH800	1800170
				1600	ASD32Q3FH1600	1800103	ASD32R3FH1600	1800137	ASD32H3FH1600	1800171
				2000	ASD32Q3FH2000	1800104	ASD32R3FH2000	1800138	ASD32H3FH2000	1800172
				2500	ASD32Q3FH2500	1800105	ASD32R3FH2500	1800139	ASD32H3FH2500	1800173
			Vertical	800	ASD32Q3FV800	1800106	ASD32R3FV800	1800140	ASD32H3FV800	1800174
				1600	ASD32Q3FV1600	1800107	ASD32R3FV1600	1800141	ASD32H3FV1600	1800175
				2000	ASD32Q3FV2000	1800108	ASD32R3FV2000	1800142	ASD32H3FV2000	1800176
				2500	ASD32Q3FV2500	1800109	ASD32R3FV2500	1800143	ASD32H3FV2500	1800177
		Drawout	Horizontal	3200	ASD32Q3FV3200	1800456	ASD32R3FV3200	1800457	ASD32H3FV3200	1800458
				800	ASD32Q3DH800	1800110	ASD32R3DH800	1800144	ASD32H3DH800	1800178
				1600	ASD32Q3DH1600	1800111	ASD32R3DH1600	1800145	ASD32H3DH1600	1800179
				2000	ASD32Q3DH2000	1800112	ASD32R3DH2000	1800146	ASD32H3DH2000	1800180
			Vertical	2500	ASD32Q3DH2500	1800113	ASD32R3DH2500	1800147	ASD32H3DH2500	1800181
				800	ASD32Q3DV800	1800114	ASD32R3DV800	1800148	ASD32H3DV800	1800182
				1600	ASD32Q3DV1600	1800115	ASD32R3DV1600	1800149	ASD32H3DV1600	1800183
				2000	ASD32Q3DV2000	1800116	ASD32R3DV2000	1800150	ASD32H3DV2000	1800184
2500	ASD32Q3DV2500	1800117	ASD32R3DV2500	1800151	ASD32H3DV2500	1800185				
3200	ASD32Q3DV3200	1800118	ASD32R3DV3200	1800152	ASD32H3DV3200	1800186				

A32 Series Power Circuit Breaker

Technical Specifications

A

A32 Power Circuit Breakers		A32Q	A32R	A32H
Poles		3 Pole 4 Pole		
Mounting Type		Fixed Drawout		
Rated Current (A)	Fixed Drawout	800 1600 2000 2500 3200		
Rated Maximum Voltage (Vac)		254 508 635		
Frequency (Hz)		50 60		
Interrupting rating at rated maximum voltage (kA)	254Vac	65	85	100
	508Vac	65	85	100
	635Vac	65	85	100
Short time withstand rating (kA)	254Vac	65	85	100
	508Vac	65	85	100
	635Vac	65	85	100
Operating time (ms)	Open	<70		
	Close	<40		
Number of operations before maintenance is required	Mechanical	10000		
	Electrical	6000		

ASD32 Non-Automatic Switches		ASD32Q	ASD32R	ASD32H
Poles		3 Pole 4 Pole		
Installation		Fixed Drawout		
Rated Current (A)	Fixed Drawout	800 1600 2000 2500 3200		
Rated Maximum Voltage (Vac)		254 508 635		
Frequency (Hz)		50 60		
Short time withstand rating (kA)	254Vac	65 85 100		
	508Vac	65	85	100
	635Vac	65	85	100
Number of operations before maintenance is required	Mechanical	10000		
	Electrical	6000		

Overall Dimensions			Height	Width	Depth	
Breaker Frame HxWxD (in)	Fixed	3 Poles 800A~1600A	15.43	16.93	14.61	
		3 Poles 2000A~2500A			15.55	
		3 Poles 3200A			17.44	
		4 Poles 800A~1600A			14.61	
	Drawout	4 Poles 2000A~2500A	16.93	17.13	15.55	
		4 Poles 3200A			17.44	
		3 Poles 800A~2500A			21.26	
		3 Poles 3200A			23.98	
Minimum Enclosure HxWxD (in)	Drawout	4 Poles 800A~2500A	21.65	21.65	21.26	
		4 Poles 3200A			23.98	
	Fixed	3 Poles		25	23.62	18.11
		4 Poles			20.47	18.11
				25	14.17	

Weight lb (kg)		Fixed	Drawout
Power Circuit Breakers - A32	3 Poles 800A~1600A	123 (56)	215 (97)
	3 Poles 2000A~2500A	133 (60)	245 (111)
	3 Poles 3200A	147 (67)	264 (120)
Non-Automatic Switches - ASD32	3 Poles 800A~1600A	117 (53)	208 (95)
	3 Poles 2000A~2500A	126 (57)	239 (208)
	3 Poles 3200A	141 (64)	258 (117)

A40 Series Power Circuit Breaker

Product Overview

Features

A40 Power circuit breakers and the accessories conform with ANSI C37.13, C37.16, C37.17 and C37.50 standards and are UL 1066 certified. A40 Power Circuit Breakers are available at 4000A and are capable of interrupting ratings up to 100kA at 635 Volts, the maximum voltage can be up to 847Vac. UL Listed and CSA Certified, the A40 family of products provide design standardization for OEM's no matter where they do business.

A40 breakers offer a broad range of available trip units, accessories, and communications options. They are the ideal OEM solution for low voltage switchgear and customized power distribution assemblies used in Data Centers, Standby Power, Industrial, Healthcare and Commercial applications.

- 254Vac to 847Vac
- 4000A
- Interrupting Capacity ratings up to 100kA @ 635Vac and 85kA @ 847Vac
- Short-Time Withstand, 100kA @ 635Vac and 85kA at 847Vac
- 50 or 60Hz operation



Accessories

- Trip Unit: LI, LSI, LSIg
- Electrical: Auxiliary Contacts, Motor Operator, Shunt Release, Undervoltage Release, Closing Release, Ready-to-Close signal contact, Neutral Current Sensor, Voltage Conversion Module, Rear Terminal Connectors, Energy-limiting maintenance switch, OFF Position Keylock Operated Lock.
- Mechanical: Pushbutton Locking Cover, Door Frame, Phase Barrier, Mechanical Interlocking with cables, Door Interlock.



QR code to download A40 Catalog



QR code to product Website

Certifications

- UL 1066, Low-Voltage AC Power Circuit Breakers
- CSA C22.2 No. 31
- ANSI C37.13 Low Voltage Power Circuit Breakers
- ANSI C37.16 Low Voltage Power Circuit Breakers Ratings, Related Requirements and Applications



A40 Series Power Circuit Breaker

Product Selection

Product Family	Number of Poles	Frame Type	Connection Type	Rated Current (A)	Interrupting Capacity		Catalog Number	Part Number
					600Vac	800Vac		
A40	3	Fixed	Vertical	4000	65kA	65kA	A40Q3FV4000	1800464
					85kA	75kA	A40R3FV4000	1800465
					100kA	85kA	A40H3FV4000	1800466

Product Family	Number of Poles	Frame Type	Connection Type	Rated Current (A)	Withstand Rating		Catalog Number	Part Number
					600Vac	800Vac		
ASD40	3	Fixed	Vertical	4000	65kA	65kA	ASD40Q3FV4000	1800476
					85kA	75kA	ASD40R3FV4000	1800477
					100kA	85kA	ASD40H3FV4000	1800478

A

A40 Series Power Circuit Breaker

Technical Specifications

A40 Power circuit breakers			A40Q	A40R	A40H
Pole			3P/4P		
Mounting Type			Fixed		
Rated current(A)			4000		
Rated Maximum Voltage (Vac)			254/508/635/847		
Frequency (Hz)			50/60		
Interrupting rating at rated maximum voltage (kA)	254Vac		65	85	100
	508Vac		65	85	100
	635Vac		65	85	100
	847Vac		65	75	85
Short time withstand current (kA)	254Vac		65	85	100
	508Vac		65	85	100
	635Vac		65	85	100
	847Vac		65	75	85
Operating time (ms)			Open		
			Close		
Life cycle (time)	Mechanical	Without maintenance	10000	10000	10000
		Without maintenance 635Vac	4000	4000	4000
	Electrical	Without maintenance 847Vac	3000	3000	3000
A40 Non Automatic Switches			ASD40Q	ASD40R	ASD40H
Pole			3P/4P		
Mounting Type			Fixed		
Rated current (A)			4000		
Rated Maximum Voltage (Vac)			254/508/635/847		
Frequency (Hz)			50/60		
Short time withstand current (kA)	254Vac		65	85	100
	508Vac		65	85	100
	635Vac		65	85	100
	847Vac		65	75	85
Operating time (ms)			Open		
			Close		
Life cycle (time)	Mechanical	Without maintenance	10000	10000	10000
		Without maintenance 635Vac	4000	4000	4000
	Electrical	Without maintenance 847Vac	3000	3000	3000
Overall Dimensions			Height	Width	Depth
Overall dimensions	Fixed	3P	15.43 (392)	17.76 (451)	12.22 (310.5)
		4P	15.43 (392)	22.32 (567)	12.22 (310.5)
Weight			lb (kg)		
A40 Power Circuit Breaker	Fixed	3P	183 (83)		
		4P	229 (104)		
ASD40 Non-Auto Switch	Fixed	3P	176 (80)		
		4P	222 (101)		

Molded Case Circuit Breakers

Product Overview

Features

Molded Case Circuit Breakers, 15-1200 Amperes

NOARK Electric offers a complete range of Molded Case Circuit Breakers in six frame sizes: M1 - 150A, M2 - 250A, M3 - 400A, M4 - 600A, M5 - 800A, and M6 - 1200A. Each frame size offers a range of interrupting ratings up to 100kA at 480Vac and voltage ratings up to 600Vac and 600Vdc.

- High-breaking capacity and a patented arc extinguishing design
- Bearing-type spindle reduces the operating force required to open and close the operating mechanism
- High quality compact modular design
- Fixed and adjustable trip unit settings
- Line and load lugs installed standard
- 5-Year limited warranty

Wide range of accessories:

- Alarm switch and auxiliary contact
- Shunt and under-voltage trip
- Rotary type handle
- Flange type handle



B



Certifications

- UL489 listed, File No. E355392
- CSA Standards C22.2 No. 5, File No. E355392
- IEC/EN 60947-2
- CE Compliant



Molded Case Circuit Breakers

M1-M6 Product Selection

Ratings Summary		M1						M2						M3			M4			M5			M6			
Rating	Amps @ 40°C	15-150						100-250						225-400			400-600			600-800			800-1200			
	Poles	1	2		3			1	2		3			2*,3			3			3			3			
	Frame Type	N	S	N	H	S	N	H	N	S	N	H	S	N	H	S	N	H	S	N	H	S	N	H	S	N
	Maximum Vac	480		600		600			480		600		600			600			600			600			600	
	Maximum Vdc	250		500		600			250		500		600			500			600			600			-	
Interrupting Capacity (kA rms)	240Vac	50	50	100	150	50	100	150	50	50	100	150	50	100	150	65	100	150	65	100	150	65	100	150	65	100
	480Vac	10	35	65	100	35	65	100	10	35	65	100	35	65	100	42	65	100	42	65	100	42	65	100	42	65
	600Vac	-	14	20	25	14	20	25	-	14	20	25	14	20	25	18	25	30	22	30	50	22	30	50	22	42
	250Vdc (1P)	25	-						25	-						-			-			-			-	
	500Vdc (2P**)	-	20	35	50	-	-	-	-	20	35	50	-	-	-	35	50	65	-			-			-	
	600Vdc (3P**)	-			20	35	50	-			20	35	50	35	50	65	35	50	65	35	50	65	35	50	65	-

*3 Pole Case **Poles Connected in Series



Amps	2-pole 80% Rated		3-pole 80% Rated	
	Catalog Number	Trip Unit	Catalog Number	Trip Unit
15	M1S15T22L	FT/FM	M1S15T3L	FT/FM
20	M1S20T22L		M1S20T3L	
25	M1S25T22L		M1S25T3L	
30	M1S30T22L		M1S30T3L	
35	M1S35T22L		M1S35T3L	
40	M1S40T22L		M1S40T3L	
45	M1S45T22L		M1S45T3L	
50	M1S50T22L	AT/FM	M1S50T3L	AT/FM
60	M1S60T22L		M1S60T3L	
70	M1S70T22L		M1S70T3L	
80	M1S80T22L		M1S80T3L	
90	M1S90T22L		M1S90T3L	
100	M1S100T22L		M1S100T3L	
125	M1S125T22L		AT/AM	
150	M1S150T22L	M1S150T3L		

M1S
2-pole & 3-pole
(35kA @ 480Vac)
(50kA @ 240Vac)
(14kA @ 600Vac)

Molded Case Circuit Breakers

M1 Product Selection



M1N150T3L

Amps	1-pole 80% Rated		2-pole 80% Rated		3-pole 80% Rated	
	Catalog Number	Trip Unit	Catalog Number	Trip Unit	Catalog Number	Trip Unit
15	M1N15T1L	FT/FM	M1N15T2L	FT/FM	M1N15T3L	FT/FM
20	M1N20T1L		M1N20T2L		M1N20T3L	
25	M1N25T1L		M1N25T2L		M1N25T3L	
30	M1N30T1L		M1N30T2L		M1N30T3L	
35	M1N35T1L		M1N35T2L		M1N35T3L	
40	M1N40T1L		M1N40T2L	M1N40T3L		
45	M1N45T1L		M1N45T2L	M1N45T3L		
50	M1N50T1L		AT/FM	M1N50T2L	AT/FM	M1N50T3L
60	M1N60T1L			M1N60T2L		M1N60T3L
70	M1N70T1L			M1N70T2L		M1N70T3L
80	M1N80T1L			M1N80T2L		M1N80T3L
90	M1N90T1L			M1N90T2L		M1N90T3L
100	M1N100T1L		M1N100T2L	M1N100T3L		
125	M1N125T1L		M1N125T2L	M1N125T3L	AT/AM	
150	M1N150T1L		M1N150T2L	M1N150T3L		

M1N
1-pole
(10kA @ 480Vac)
(50kA @ 240Vac)
2-pole & 3-pole
(65kA @ 480Vac)
(100kA @ 240Vac)
(20kA @ 600Vac)

B



M1H150T3L

Amps	2-pole 80% Rated		3-pole 80% Rated	
	Catalog Number	Trip Unit	Catalog Number	Trip Unit
15	M1H15T2L	FT/FM	M1H15T3L	FT/FM
20	M1H20T2L		M1H20T3L	
25	M1H25T2L		M1H25T3L	
30	M1H30T2L		M1H30T3L	
35	M1H35T2L		M1H35T3L	
40	M1H40T2L	AT/FM	M1H40T3L	AT/FM
45	M1H45T2L		M1H45T3L	
50	M1H50T2L		M1H50T3L	
60	M1H60T2L		M1H60T3L	
70	M1H70T2L		M1H70T3L	
80	M1H80T2L	AT/AM	M1H80T3L	AT/AM
90	M1H90T2L		M1H90T3L	
100	M1H100T2L		M1H100T3L	
125	M1H125T2L		M1H125T3L	
150	M1H150T2L		M1H150T3L	

M1H
2-pole & 3-pole
(100kA @ 480Vac)
(150kA @ 240Vac)
(25kA @ 600Vac)

A = Adjustable
T = Thermal
F = Fixed
M = Magnetic

Molded Case Circuit Breakers

M2 Product Selection



M2S250T3L

Amps	2-pole 80% Rated		3-pole 80% Rated	
	Catalog Number	Trip Unit	Catalog Number	Trip Unit
	100	M2S100T22L	AT/AM	M2S100T3L
125	M2S125T22L	M2S125T3L		
150	M2S150T22L	M2S150T3L		
175	M2S175T22L	M2S175T3L		
200	M2S200T22L	M2S200T3L		
225	M2S225T22L	M2S225T3L		
250	M2S250T22L	M2S250T3L		

M2S
2-pole & 3-pole
(35kA @ 480Vac)
(50kA @ 240Vac)
(14kA @ 600Vac)

Amps	1-pole 80% Rated		2-pole 80% Rated		3-pole 80% Rated	
	Catalog Number	Trip Unit	Catalog Number	Trip Unit	Catalog Number	Trip Unit
100	M2N100T1L	FT/FM	M2N100T22L	AT/AM	M2N100T3L	AT/AM
125	M2N125T1L		M2N125T22L		M2N125T3L	
150	M2N150T1L		M2N150T22L		M2N150T3L	
175	M2N175T1L		M2N175T22L		M2N175T3L	
200	M2N200T1L		M2N200T22L		M2N200T3L	
225	M2N225T1L		M2N225T22L		M2N225T3L	
250	M2N250T1L		M2N250T22L		M2N250T3L	

M2N
1-pole
(10kA @ 480Vac)
(50kA @ 240Vac)
2-pole & 3-pole
(65kA @ 480Vac)
(100kA @ 240Vac)
(20kA @ 600Vac)

Amps	2-pole* 80% Rated		3-pole 80% Rated	
	Catalog Number	Trip Unit	Catalog Number	Trip Unit
100	M2H100T2L	AT/AM	M2H100T3L	AT/AM
125	M2H125T2L		M2H125T3L	
150	M2H150T2L		M2H150T3L	
175	M2H175T2L		M2H175T3L	
200	M2H200T2L		M2H200T3L	
225	M2H225T2L		M2H225T3L	
250	M2H250T2L		M2H250T3L	

M2H
2-pole & 3-pole
(100kA @ 480Vac)
(150kA @ 240Vac)
(25kA @ 600Vac)

A = Adjustable
T = Thermal
F = Fixed
M = Magnetic
*3-pole Case

Line & Load Lugs: #3 AWG - 300kcmil, (1) Cu or Al wire

Molded Case Circuit Breakers

M3-M4 Product Selection

Amps	2-pole* 80% Rated		3-pole 80% Rated		
	Catalog Number	Trip Unit	Catalog Number	Trip Unit	
M3S 2-pole & 3-pole (42kA @ 480Vac) (65kA @ 240Vac) (18kA @ 600Vac)	225	M3S225T2L	AT/AM	M3S225T3L	AT/AM
	250	M3S250T2L		M3S250T3L	
	300	M3S300T2L		M3S300T3L	
	350	M3S350T2L		M3S350T3L	
	400	M3S400T2L		M3S400T3L	

Amps	3-pole 80% Rated		
	Catalog Number	Trip Unit	
M4S 3-pole (42 kA @ 480 Vac) (65 kA @ 240 Vac) (22 kA @ 600 Vac)	400	M4S400T3L	AT/AM
	500	M4S500T3L	
	600	M4S600T3L	

B

Amps	2-pole* 80% Rated		3-pole 80% Rated		
	Catalog Number	Trip Unit	Catalog Number	Trip Unit	
M3N 2-pole & 3-pole (65kA @ 480Vac) (100kA @ 240Vac) (25kA @ 600Vac)	225	M3N225T2L	AT/AM	M3N225T3L	AT/AM
	250	M3N250T2L		M3N250T3L	
	300	M3N300T2L		M3N300T3L	
	350	M3N350T2L		M3N350T3L	
	400	M3N400T2L		M3N400T3L	

Amps	3-pole 80% Rated		
	Catalog Number	Trip Unit	
M4N 3-pole (65kA @ 480Vac) (100 A @ 240Vac) (30kA @ 600Vac)	400	M4N400T3L	AT/AM
	500	M4N500T3L	
	600	M4N600T3L	

Amps	2-pole* 80% Rated		3-pole 80% Rated		
	Catalog Number	Trip Unit	Catalog Number	Trip Unit	
M3H 2-pole & 3-pole (100kA @ 480Vac) (150kA @ 240Vac) (30kA @ 600Vac)	225	M3H225T2L	AT/AM	M3H225T3L	AT/AM
	250	M3H250T2L		M3H250T3L	
	300	M3H300T2L		M3H300T3L	
	350	M3H350T2L		M3H350T3L	
	400	M3H400T2L		M3H400T3L	

Amps	3-pole 80% Rated		
	Catalog Number	Trip Unit	
M4H 3-pole (100kA @ 480Vac) (150kA @ 240Vac) (50kA @ 600Vac)	400	M4H400T3L	AT/AM
	500	M4H500T3L	
	600	M4H600T3L	

Line & Load Lugs: #4/0 AWG - 600kcmil,
(1) Cu or Al wire

Line & Load Lugs: #2/0 AWG - 500kcmil, (2) Cu or Al wire

A = Adjustable
T = Thermal
F = Fixed
M = Magnetic
*3-pole Case

Molded Case Circuit Breakers

M5-M6 Product Selection

M5S 3-pole (42kA @ 480Vac) (65kA @ 240Vac) (22kA @ 600Vac)	Amps	3-pole 80% Rated	
		Catalog Number	Trip Unit
		600	M5S600T3L
700	M5S700T3L		
800	M5S800T3L		

M6S* 3-pole (42kA @ 480Vac) (65kA @ 240Vac) (22kA @ 600Vac)	Amps	3-pole		
		80% Rated	100% Rated	
		Catalog Number	Catalog Number	Trip Unit
800	M6S800E3W4L	M6S800E3W4LF	ET	
1000	M6S1000E3W4L	M6S1000E3W4LF		
1200	M6S1200E3W4L	M6S1200E3W4LF		

M5N 3-pole (65kA @ 480Vac) (100kA @ 240Vac) (30kA @ 600Vac)	Amps	3-pole 80% Rated	
		Catalog Number	Trip Unit
		600	M5N600T3L
700	M5N700T3L		
800	M5N800T3L		

M6N* 3-pole (65kA @ 480Vac) (100kA @ 240Vac) (42kA @ 600Vac)	Amps	3-pole		
		80% Rated	100% Rated	
		Catalog Number	Catalog Number	Trip Unit
800	M6N800E3W4L	M6N800E3W4LF	ET	
1000	M6N1000E3W4L	M6N1000E3W4LF		
1200	M6N1200E3W4L	M6N1200E3W4LF		

M5H 3-pole (100kA @ 480Vac) (150kA @ 240Vac) (50kA @ 600Vac)	Amps	3-pole 80% Rated	
		Catalog Number	Trip Unit
		600	M5H600T3L
700	M5H700T3L		
800	M5H800T3L		

Series M6 Line & Load Lugs:

- 1000A Max - #3/0 AWG - 750kcmil, (3) Cu or Al wire
- 1200A - #3/0 AWG - 500kcmil, (4) Cu or Al wire

Series M5 Line & Load Lugs:

- 700A Max - 250kcmil - 600kcmil, (2) Cu or Al wire
- 800A - #4/0 AWG - 500kcmil, (3) Cu or Al wire

A = Adjustable
 T = Thermal
 F = Fixed
 M = Magnetic
 ET = Electronic

* M6S and M6N breakers offers ground fault protection in 3P-4W and arc energy reduction system with remote switch. External neutral current sensor, NCS26N is required for ground fault protection while ELM20 is required for arc energy reduction function. Both are ordered separately (See page 33 for more information)

Molded Case Circuit Breakers

M1-M6 Technical Data

Ratings & Specifications		M1						M2							
Amps @ 40°C		15-150						100-250							
Poles		1	2		3			1	2		3				
Frame Type		N	S	N	H	S	N	H	N	S	N	H*	S	N	H
Maximum Vac		480	600		600			480	600		600				
Maximum Vdc		250	500		500			250	500		500				
Interrupting Capacity (kA rms)															
240Vac		50	50	100	150	50	100	150	50	50	100	150	50	100	150
480Vac		10	35	65	100	35	65	100	10	35	65	100	35	65	100
600Vac		-	14	20	25	14	20	25	-	14	20	25	14	20	25
250Vdc 1-pole		25	-						25	-					
500Vdc 2-poles**		-	20	35	50	20	35	50	-	20	35	50	20	35	50
600Vdc 3-poles**		-			20	35	50	-			20	35	50		
*3-pole Case															
**Poles Connected in Series															
General Specifications															
Insulation Voltage (V)		800Vac						800Vac							
Impulse Withstand Voltage (Vimp)		8kVac						8kVac							
Operational Voltage (Ve)(IEC)		690Vac						690Vac							
Operational Voltage (Ve)(UL)		600Vac						600Vac							
Utilization Category		A						A							
Mechanical Operating Cycles		10,000						10,000							
Electrical Operating Cycles		6,000						6,000							
Trip Unit Type		FT/FM	15~45 FT/FM 50~150A AT/FM			15~45A FT/FM 50~100A AT/FM 125~150A AT/AM			FT/ FM	AT/AM					
A=Adjustable / T=Thermal / F=Fixed / M=Magnetic															
Dimensions LxWxD in (mm)		1-pole	6.46x1.4x3.33 (164x35x84.5)						7.17x1.57x3.47 (182x40x88)						
		2-pole	6.46x2.44x3.33 (164x62x84.5)						7.17x2.95x3.47 (182x75x88)						
		2-pole*	6.46x3.54x3.33 (164x90x84.5)						7.17x4.13x3.47 (182x105x88)						
		3-pole													
		4-pole													
Wiegth lb (kg)		1-pole	1.47 (0.67)						1.76 (0.8)						
		2-pole	2.53 (1.15)						3.3 (1.5)						
		2-pole*	3.17 (1.67)						3.75 (1.70)						
		3-pole	3.68 (1.67)						4.41 (2.00)						
		4-pole													
Cable Lug Size 75°C Cu or Al Wire Only AWG (mm²)		1-Hole, #14-3/0 (2.5-95) Cu OR 1-Hole, #12-3/0 (2.5-95) Al						1-Hole, #3-300 kcmil (35-150)							
Lug Torque in-lb (Nm)		89 (10)						230 (23)							

B

Molded Case Circuit Breakers

M1-M6 Technical Data

Ratings & Specifications		M3			M4			M5			M6	
Amps @40°C		225-400			400-600			600-800			800-1200	
Poles		2*,3			2*,3			2*,3,4			3,4	
Frame Type		S	N	H	S	N	H	S	N	H	S	N
Maximum Vac		600			600**			600**			600	
Maximum Vdc		600			600**			600**			-	
Interrupting Capacity (kA rms)												
240Vac		65	100	150	65	100	150	65	100	150	65	100
480Vac		42	65	100	42	65	100	42	65	100	42	65
600Vac		18	25	30	22	30	50	22	30	50	22	42
250Vdc 1-pole		-			-			-			-	
500Vdc 2-pole**		35	50	65	35	50	65	35	50	65	-	
600Vdc 3-pole**		35	50	65	35	50	65	35	50	65	-	
*3-pole Case												
**Pole Connected in Series												
General Specifications												
Insulation Voltage (Vi)		800Vac			800Vac			800Vac			800Vac	
Impulse Withstand Voltage (Vimp)		8kVac			8kVac			8kVac			8kVac	
Operational Voltage (Ve) (IEC)		690Vac			690Vac			690Vac			690Vac	
Operational Voltage (Ve) (UL)		600Vac			600Vac			600Vac			600Vac	
Utilization Category		A			A			A			A	
Mechanical Operating Cycles		8,000			8,000			3,000			3,000	
Electrical Operating Cycles		5,000			5,000			500			500	
Trip Unit Type		AT/AM			AT/AM			AT/AM			Electronic*	
Dimensions LxWxD in (mm)		2-pole*			2-pole*			2-pole*			2-pole*	
		3-pole			3-pole			3-pole			3-pole	
		4-pole			4-pole			4-pole			4-pole	
Weight lb (kg)		2-pole*			2-pole*			2-pole*			2-pole*	
		3-pole			3-pole			3-pole			3-pole	
		4-pole			4-pole			4-pole			4-pole	
Cable Lug Size 75°C CU or AL Wire Only AWG (mm ²)		Standard: 1-Hole, #4/0-600 kcmil (95-240)			2-Holes #2/0-500 kcmil (2x 95-185)			2-Holes 250-600 kcmil (120-300)			3-Holes #3/0-750 kcmil (95-300)	
		2-Holes #3-250 kcmil (35-120)						3-Holes #4/0-500 kcmil (100-250)			4-Holes #3/0-500 kcmil (95-240)	
Lug Torque in-lb (Nm)		310 (35)			310 (35)			398 (45)			310 (35)	

*Electronic trip units are equipped with LSIG protection

Additional products, accessories and higher ratings available. Contact your NOARK representative or visit na.noark-electric.com for additional information.

Molded Case Switches

Product Overview

Features

Molded Case Switches, 100-1200 Amperes

NOARK Electric offers a complete range of Molded Case Switches in six frame sizes: M1 - 150A, M2 - 250A, M3 - 400A, M4 - 600A, M5 - 800A, and M6 - 1200A. Each frame size offers a range of interrupting ratings at 240-690Vac and 250-600Vdc. Molded Case Switches are only used as disconnect switches.

Features:

- Instantaneous trip ability and a patented arc extinguishing design
- Bearing-type spindle reduces the operating force required to open and close the operating mechanism
- High-quality compact modular design
- 5-Year limited warranty

Wide range of accessories:

- Alarm switch and auxiliary contact
- Shunt and under-voltage trip
- Rotary type handle
- Flange type handle



Certifications

- UL489 listed, File No. E355396
- CSA Standards C22.2 No. 5, File No. E355396
- IEC/EN 60947-2
- CE Compliant



Molded Case Switches

Line/Load Lug Connection

- Terminal lugs are provided standard on all NOARK MCCBs.
- Additional terminal lug configurations available. See pages 37-38



Withstand Rating* (kA rms)	Rated Amperes (A)	Line/Load Lug Connection		Lug Configuration
		2-pole	3-pole	
		Catalog Number		
M1D (100kA @ 240Vac) (65kA @ 480Vac) (20kA @ 600Vac)	100	M1D1002L	M1D1003L	1 Conductor
	150	M1D1502L	M1D1503L	#14 to #3/0 AWG Cu OR #12 to #3/0 AWG Al
M2D (100kA @ 240Vac) (65kA @ 480Vac) (20kA @ 600Vac)	225	M2D2252L	M2D2253L	1 Conductor
	250	M2D2502L	M2D2503L	#3 AWG to 300kcmil Cu or Al
M3D (100kA @ 240Vac) (65kA @ 480Vac) (25kA @ 600Vac)	400	-	M3D4003L	1 Conductor #4/0 AWG to 600 kcmil Cu or Al
M4D (100kA @ 240Vac) (65kA @ 480Vac) (30kA @ 600Vac)	600	-	M4D6003L	2 Conductor #2/0 AWG to 500 kcmil Cu or Al
M5D (100kA @ 240Vac) (65kA @ 480Vac) (30kA @ 600Vac)	800	-	M5D8003L	3 Conductor #4/0 AWG to 500kcmil Cu or Al
M6D (100kA @ 240Vac) (65kA @ 480Vac) (42kA @ 600Vac)	1000	-	M6D10003LF	3 Conductor #3/0 AWG to 750kcmil Cu or Al
	1200	-	M6D12003LF	4 Conductor #3/0 AWG to 500kcmil Cu or Al

Additional products, accessories and higher ratings available. Contact your NOARK representative or visit na.noark-electric.com for additional information.

Molded Case Switches

M1D - M6D Technical Data

		M1D	M2D	M3D	M4D	M5D	M6D
Rated Current (A)		100 - 150	225 - 250	400	600	800	1000 -1200
Number of Poles		2, 3		3			
Switch Type		M1D	M2D	M3D	M4D	M5D	M6D
Rated Voltage 50/60Hz	Vac	600					
	Vdc	600					-
Withstand Rating* (kA rms)							
Circuit Breaker Ratings UL 489- -C-SA C22.2 (kA rms) Vac 50/60Hz	240Vac	100	100	100	100	100	100
	480Vac	65	65	65	65	65	65
	600Vac	20	20	25	30	30	42
	500Vdc 2-pole	35	35	50	50	50	-
	600Vdc 3-pole	35	35	50	50	50	-
Circuit Breaker Ratings IEC 60947-2	220 / 240Vac	100	100	100	100	100	85 (60) Icu/Ics
	380 / 415Vac						
Ultimate Breaking Capacity (Icu = 100% Ics) (kA rms)	660 / 690Vac	8	10	15	15	15	30
	500Vdc 3-pole	35	35	50	50	-	-
	500Vdc 2-pole	35	35	50	50	50	-
Trip Current (A)		15xIn	12xIn	12xIn	10xIn	10xIn	15xIn
Connection							
Line/Load Lug Connection		■					
Insulation Voltage (Vi)		800Vac					
Impulse Withstand Voltage (Vimp)		8kVac					
Operational Voltage (Ve) UL		600Vac					
Mechanical Operating Cycles		10,000		8,000		3,000	
Electrical Operating Cycles		6,000		5,000		500	
Dimensions LxWxD in		6.46x3.54x3.33	7.17x4.13x3.47	11.22x5.51x4.59	12.32x7.68x5.43	16.18x7.68x7.58	17.72x8.27x6.6
Weight of Unit lb	2-pole	3.17	3.75	-	-	-	-
	3-pole	3.68	4.41	13.45	25.35	33.18	55.56
Lugs lb-in (N.m)		89 (10)	230 (23)	310 (35)		398 (45)	310 (35)

*NOTE: Molded Case Switches do not provide branch circuit protection and must be protected by an upstream OCPD (fuse or circuit breaker). The withstand rating is provided for coordination purposes and refers to the fault, at rated voltage, that the molded case switch can withstand without damage when protected by a circuit breaker or fuse with an equal continuous current rating

Additional products, accessories and higher ratings available. Contact your NOARK representative or visit na.noark-electric.com for additional information.

Molded Case Motor Circuit Protectors

Product Overview

Features

Molded Case Motor Circuit Protectors, 3-1200 Amperes

NOARK Electric offers a complete range of 3 pole Molded Case Motor Circuit Protectors (MCPs, magnetic or short circuit protection only) which are used to protect the cables feeding three phase motors in six frame sizes: M1M - 150A, M2M - 250A, M3M - 400A, M4M - 600A, M5M - 800A, and M6M - 1200A. Each frame size offers a range of interrupting ratings at 240-690Vac and 250-600Vdc.

The National Electrical Code (NEC) requires the following when controlling a motor:

- A means of disconnecting power from the circuit
- Short circuit protection for the cables
- A way to start and stop the motor (typically a contactor)
- Overload protection for the motor (typically an overload relay)

A motor circuit protector serves as means of disconnecting power and short circuit protection for the cables.



Certifications

- UL489 Recognized Component, File No. E355392
- CSA Standard C22.2 No. 5, File No. E355392
- IEC/EN 60947-2
- CE Compliant



Molded Case Motor Circuit Protectors

Line/Load Lug Connection

- Additional terminal lug configurations available. See pages 37-38
- Terminal lugs are provided standard on all NOARK MCCBs.



Rated Amperage (A)	Magnetic Trip Setting Range	Line/Load Lug Connection		Lug Configuration
		S Interrupting	N Interrupting	
		50kA @ 240Vac 35kA @ 480Vac 14kA @ 600Vac	100kA @ 240Vac 65kA @ 480Vac 20kA @ 600Vac	
Catalog Number				
3	7x-11x	M1MS03T3L	M1MN03T3L	1 Conductor #14 to #3/0 AWG Cu OR #12 to #3/0 AWG Al
7	5x-10x	M1MS07T3L	M1MN07T3L	
15	5x-10x	M1MS15T3L	M1MN15T3L	
30	5x-11x	M1MS30T3L	M1MN30T3L	
50	5x-11x	M1MS50T3L	M1MN50T3L	
70	5x-11x	M1MS70T3L	M1MN70T3L	
100	5x-11x	M1MS100T3L	M1MN100T3L	
150	5x-11x	M1MS150T3L	M1MN150T3L	1 Conductor #3 AWG to 300kcmil Cu or Al
250	5x-11x	M2MS250T3L	M2MN250T3L	

Rated Amperage (A)	Magnetic Trip Setting Range	Line/Load Lug Connection		Lug Configuration
		S Interrupting	N Interrupting	
		65kA @ 240Vac 42kA @ 480Vac 18kA @ 600Vac	100kA @ 240Vac 65kA @ 480Vac 25kA @ 600Vac	
Catalog Number				
400	5x-11x	M3MS400T3L	M3MN400T3L	1 Conductor #4/0 AWG to 600kcmil Cu or Al

Rated Amperage (A)	Magnetic Trip Setting Range	Line/Load Lug Connection			Lug Configuration
		S Interrupting	N Interrupting	N Interrupting	
		65kA @ 240Vac 42kA @ 480Vac 22kA @ 600Vac	100kA @ 240Vac 65kA @ 480Vac 30kA @ 600Vac	100kA @ 240Vac 65kA @ 480Vac 42kA @ 600Vac	
Catalog Number					
600	5x-11x	M4MS600T3L	M4MN600T3L	-	2 Conductor #2/0 AWG to 500kcmil Cu or Al
800	5x-11x	M5MS800T3L	M5MN800T3L	-	3 Conductor #4/0 AWG to 500kcmil Cu or Al
1200	2x-12x	M6MS1200E3LF	-	M6MN1200E3LF	4 Conductor #3/0 AWG to 500kcmil Cu or Al

Additional products, accessories and higher ratings available. Contact your NOARK representative or visit na.noark-electric.com for additional information.

Molded Case Motor Circuit Protectors

M1M - M6M Technical Data

		M1M		M2M		M3M		M4M		M5M		M6M	
Current Range (A)		3-150		250		400		600		800		1200	
Number of Poles		3											
Breaker Type		S	N	S	N	S	N	S	N	S	N	S	N
Rated Voltage 50/60 Hz Vac		600											
Interrupting Capacity (kA)													
Circuit Breaker Ratings	240Vac	50	100	50	100	65	100	65	100	65	100	65	100
	480Vac	35	65	35	65	42	65	42	65	42	65	42	65
	600Vac	14	20	14	20	18	25	22	30	22	30	22	42
Magnetic Trip Units	A = Adjustable M = Magnetic	AM											
Accessories													
Alarm Switch													
Auxiliary Contact													
Shunt Trip													
Under-Voltage Trip		■											
Handle Lock													
Flange Type Handle													
Rotary Type Handle													
Connection													
Line/Load Lug Connection		■											
Dimensions In (mm)		6.46x3.54x3.33 (164x90x34.5)	7.17x4.13x3.47 (182x105x38)	11.22x5.51x4.59 (285x140x116.5)	12.32x7.68x5.43 (313x195x138)	16.18x7.68x7.58 (411x195x192.5)	17.72x8.27x6.6 (450x210x167.6)						
Weight Lb (kg)		3.68 (1.67)	4.41 (2)	13.45 (6.1)	25.35 (11.5)	33.18 (15.05)	55.56 (25.2)						

Molded Case Circuit Breakers

Temperature & Altitude Compensation

Rated Current	Temperature	+40°C	+50°C	+60°C	+70°C
M1	15A	15	14.3	12.9	12
	20A	20	19	17.2	16
	25A	25	24	21.5	20
	30A	30	28.1	25.8	24
	35A	35	32.8	30.1	28
	40A	40	38	34.4	32
	45A	45	42.5	48.7	36
	50A	50	47.5	43	40
	60A	60	57	51.6	48
	70A	70	66.5	60.2	56
	80A	80	76	68.8	64
	90A	90	85.5	77.4	72
	100A	100	95	86	80
	125A	125	112.5	107.5	100
M2	150A	150	135	129	120
	125A	125	112.5	100	87.5
	150A	150	135	120	105
	175A	175	166.2	157.5	148.7
	200A	200	190	180	170
	225A	225	202.5	184.5	168
M3	250A	250	237.5	225	195
	250A	250	237.5	212.5	187.5
	300A	300	285	255	225
	350A	350	332.5	297.5	262.5
M4	400A	400	380	340	300
	400A	400	380	360	340
	500A	500	465	430	400
M5	600A	600	558	516	480
	600A	600	558	516	480
	700A	700	644	595	546
M6	800A	800	736	680	624
	800A	800	800	800	800
	1000A	1000	1000	1000	900
	1200A	1200	1080	1080	960

D

Altitude m		2000m	3000m	4000m	5000m
I _n		1×I _n	0.96×I _n	0.93×I _n	0.9×I _n
U _e (V)	AC/DC	600	480	420	360
Dielectric properties (V)	AC/DC	2400	2000	1680	1440
Rated insulation impulse voltage U _{imp} (kV)		8	8	8	8

Accessories For MCCB/MCP/MCS

Internal Accessories

Alarm Switch (AL)

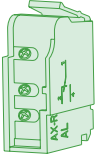

Function:

- Sends a signal when the circuit breaker trips
- UL File Number E355392

1

Auxiliary Contact (AX)



Function:

- Indicates the state of a circuit breaker (on/off)
- UL File Number E355392

2

Accessory Description	Rated Operational Voltage	Rated Operational Current	Catalog Number
Alarm Switch 1NO / 1NC	240/480Vac, 110/220Vdc	0.25A @ 110Vdc 0.25A @ 220Vdc	AL/AX21P*
Auxiliary Contact 1NO / 1NC		5A @ 240Vac 2A @ 480Vac*	

*AL/AX21P is an Alarm switch when inserted in position '1' on the breaker and Auxiliary contact when inserted in position '2' on the breaker

Shunt Release (SHT)

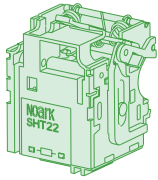

Function:

- Allows circuit breaker to be remotely operated
- Response Voltage, Pick-Up: Us 70-110%
- Opening Time: Interrupts Automatically $\geq 10\text{ms}$, $\leq 60\text{ms}$
- UL File Number E355392

3

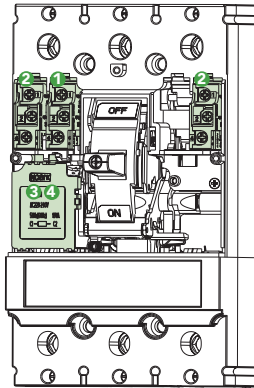

Under-Voltage Trip (UVT)

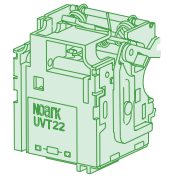

Function:

- Prevents circuit breaker from closing during an under-voltage situation
- Response Voltage, Drop: Ue 35-70%
- Response Voltage, Pick-Up: Ue 85-110%
- Opening Time: Interrupts Automatically $\geq 10\text{ms}$, $\leq 60\text{ms}$
- UL File Number E355392

4

Accessory Description	Frame Size	Voltage	Catalog Number
Shunt Trip	M1	100-130Vac	SHT21NA
		220-240Vac	SHT21NB
		12Vdc	SHT21ND
		24Vdc	SHT21NI
	110 - 125Vdc	SHT21NG	
	M2-M3	100-130Vac	SHT22NA
		220-240Vac	SHT22NB
		12Vdc	SHT22NI
		24Vdc	SHT22NE
	110 - 125Vdc	SHT22NG	
	M4-M5	100-130Vac	SHT24NA
		220-240Vac	SHT24NB
		12Vdc	SHT24NI
		24Vdc	SHT24NE
	110 - 125Vdc	SHT24NG	
	M6	100 - 130Vac	SHT26NA
220-240Vac		SHT26NB	
480-500Vac		SHT26ND	
24-30Vdc		SHT26NE	
110 - 125Vdc	SHT26NG		

Accessory Description	Frame Size	Voltage	Catalog Number
Under-Voltage Trip	M1	110-127Vac	UVT21NA
		220-240Vac	UVT21NB
		24-30Vdc	UVT21ND
	M2-M3	110-127Vac	UVT22NA
		220-240Vac	UVT22NB
	M4-M5	24-30Vdc	UVT22ND
		110-127Vac	UVT24NA
	M6	220-240Vac	UVT24NB
		24-30Vdc	UVT24ND
		480-500Vac	UVT26NC1

Additional products, accessories and higher ratings available. Contact your NOARK representative or visit na.noark-electric.com for additional information.

Accessories For MCCB/MCP/MCS

Internal Accessories: Alarm Switch and Auxillary Contact



5A @ 240Vac
 2A @ 480Vac
 0.25A @ 110Vdc
 0.25A @ 220Vdc

AL/AX	21	P
Description	Type	Device Category
Alarm Auxiliary Contact	21: for M1-M6	P: UL 489

Accessory Description	Product	Part Number
Alarm Auxiliary Contact	AL/AX21P	1100554

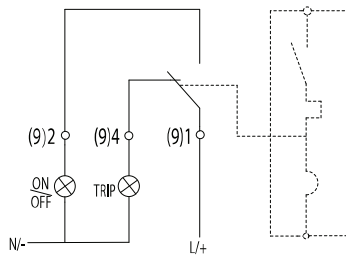

Wiring Diagram of Alarm Contact (Switch)

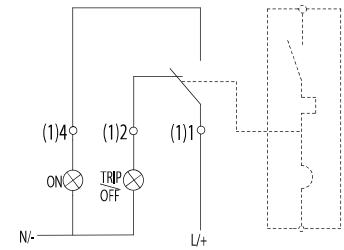

Wiring Diagram of Auxillary Contact

D

Accessories For MCCB/MCP/MCS

Internal Accessories: Shunt Trip



- Response Voltage, Pick-Up: Us 70-110%
- Opening Time: Interrupts Automatically ≥ 10 ms, ≤ 60 ms

SHT	21	N	A
Description	Type	Device Category	Control Voltage
Shunt Trip	21: for M1 22: for M2-M3, M3HV 22V: for MV2DPV 23: for MD3HV 24: for M4-M5 26: for M6	N: UL 489	A: 100~130Vac B: 220~240Vac C: 380~440Vac D: 480~500Vac E: 24Vdc H: 220~250Vdc

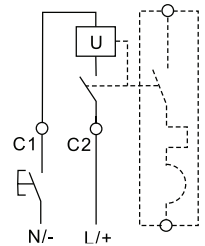

Accessory Description	Type	Control Voltage	Power Consumption	Catalog Number	Item Number
Shunt trip	M1	100-130Vac	94VA	SHT21NA	1100505
		220-240Vac	325VA	SHT21NB	1100506
		380-440Vac	152VA	SHT21NC	1100507
		480-500Vac	197VA	SHT21ND	1100508
		24Vdc	85W	SHT21NE	1100509
		110-125Vdc	87W	SHT21NG	1100511
		220-250Vdc	67W	SHT21NH	1100512
		12Vdc	95W	SHT21NI	1102721
	M2-M3	100-130Vac	228VA	SHT22NA	1100513
		220-240Vac	427VA	SHT22NB	1100514
		380-440Vac	255VA	SHT22NC	1100515
		480-500Vac	329VA	SHT22ND	1100516
		24Vdc	57W	SHT22NE	1100517
		110-125Vdc	65W	SHT22NG	1100519
		220-250Vdc	104W	SHT22NH	1100520
	M4-M5	100-130Vac	228VA	SHT24NA	1100521
		220-240Vac	427VA	SHT24NB	1100522
		380-440Vac	225VA	SHT24NC	1100523
		480-500Vac	329VA	SHT24ND	1100524
		24Vdc	57W	SHT24NE	1100525
		110-125Vdc	65W	SHT24NG	1100527
		220-250Vdc	104W	SHT24NH	1100528
	M6	100-130Vac	31VA	SHT26NA	1101168
		220-240Vac	92VA	SHT26NB	1101169
380-440Vac		75VA	SHT26NC	1101170	
480-500Vac		75VA	SHT26ND	1101171	
24Vdc		14W	SHT26NE	1101172	
110-125Vdc		44W	SHT26NG	1101173	
220-250Vdc		92W	SHT26NH	1101174	

Accessories For MCCB/MCP/MCS

Internal Accessories: Under-Voltage Trip



- Response Voltage, Drop: U_e 35-70%
- Response Voltage, Pick-Up: U_e 85-110%
- Opening Time: Interrupts Automatically ≥ 10 ms, ≤ 60 ms

UVT	21	N	A
Description	Type	Device Category	Control Voltage
Under-Voltage Trip	21: for M1 22: for M2-M3, M3HV 24: for M4-M5 26: for M6	N: UL 489	A: 110~127Vac B: 220~240Vac C: 380~440Vac D: 24~30Vdc E: 48Vdc F: 60Vdc G: 110~125Vdc H: 220~250Vdc

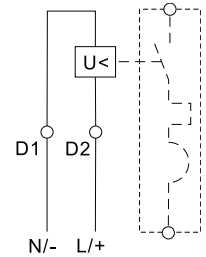

Accessory Description	Type	Control Voltage	Power Consumption	Catalog Number	Item Number
Undervoltage Trip	M1	110-127Vac	2 VA	UVT21NA	1100529
		220-240Vac	2.4 VA	UVT21NB	1100530
		380-440Vac	2.4 VA	UVT21NC	1100531
		24-30Vdc	1.5 W	UVT21ND	1100532
		48Vdc	1.6 W	UVT21NE	1100533
		60Vdc	1.7 W	UVT21NF	1100534
		110-125Vdc	2 W	UVT21NG	1100535
		220-250Vdc	2.6 W	UVT21NH	1100536
	M2-M3	110-127Vac	1.7 VA	UVT22NA	1100537
		220-240Vac	2.8 VA	UVT22NB	1100538
		380-440Vac	2.8 VA	UVT22NC	1100539
		24-30Vdc	1.7 W	UVT22ND	1100540
		48Vdc	1.5 W	UVT22NE	1100541
		60Vdc	1.5 W	UVT22NF	1100542
		110-125Vdc	1.6 W	UVT22NG	1100543
		220-250Vdc	2.9 W	UVT22NH	1100544
	M4-M5	110-127Vac	1.7 VA	UVT24NA	1100545
		220-240Vac	2.8 VA	UVT24NB	1100546
		380-440Vac	2.8 VA	UVT24NC	1100547
		24-30Vdc	1.7 W	UVT24ND	1100548
		48Vdc	1.5 W	UVT24NE	1100549
		60Vdc	1.5 W	UVT24NF	1100550
		110-125Vdc	1.6 W	UVT24NG	1100551
		220-250Vdc	2.9 W	UVT24NH	1100552
	M6	220-240Vac	2 VA	UVT26NB	1101176
		24-30Vdc	1.5 W	UVT26ND	1101179
		110-125Vdc	4 W	UVT26NG	1101180
		220-250Vdc	2 W	UVT26NH	1101181

D

Accessories For MCCB/MCP/MCS

External Accessories: Motor Operator



MOD	21	N	A
Description	Type	Device Category	Control Voltage
Motor Operator	21: for M1	N: UL 489	A: 120Vac/dc
	22: for M2		B: 240Vac/dc
	23: for M3		C: 24Vdc
	24: for M4-M5		

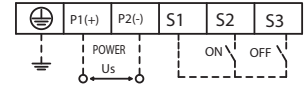

MOD21N / MOD22N

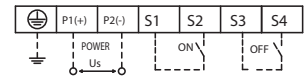

MOD23N / MOD24N

Accessory Description	Type	Voltage	Product	Part Number
Motor Operator	M1	120Vac/dc	MOD21NA	1100563
		240Vac/dc	MOD21NB	1100564
		24Vdc	MOD21NC	1100565
	M2	120Vac/dc	MOD22NA	1100566
		240Vac/dc	MOD22NB	1100567
		24Vdc	MOD22NC	1100568
	M3	120Vac/dc	MOD23NA	1100569
		240Vac/dc	MOD23NB	1100570
		24Vdc	MOD23NC	1100571
	M4-M5	120Vac/dc	MOD24NA	1100572
		240Vac/dc	MOD24NB	1100573
		24Vdc	MOD24NC	1100574

Type	Power Consumption			
	MOD21N	MOD22N	MOD23N	MOD24N
230Vac	150VA	150VA	300VA	300VA
110Vac	150VA	150VA	300VA	300VA
220Vdc	150W	150W	300W	300W
110Vdc	150W	150W	300W	300W
24Vdc	75W	75W	180W	180W

	MOD21N	MOD22N	MOD23N	MOD24N
Closing Time	≤500ms	≤500ms	≤1000ms	≤1000ms
Opening Time	≤500ms	≤500ms	≤1000ms	≤1000ms
ON-Pulse Minimum Duration	300ms	300ms	300ms	300ms
OFF-Pulse Minimum Duration	300ms	300ms	300ms	300ms
Wire Capacity	24~16 AWG	24~16 AWG	24~16 AWG	24~16 AWG
Tightening Torque of Terminal	≤8Kg/cm	≤8Kg/cm	≤9Kg/cm	≤9Kg/cm
Mechanical Operating Cycles	10000	10000	8000	8000
Operating Frequency per hour	120	120	120	60

Accessories For MCCB

External Accessories: Neutral Sensor and ELM20

Neutral Current Sensor

M6 3P4W protects circuit from ground fault, without cutting off the circuit due to faults on neutral. According to NEC Article 250.20(D) - "In three-phase, four-wire power systems, the neutral point shall not be required to be connected to an overcurrent device, but measures shall be taken to ensure that the neutral point is connected to the grounding system in a manner that establishes reliable fault current path."

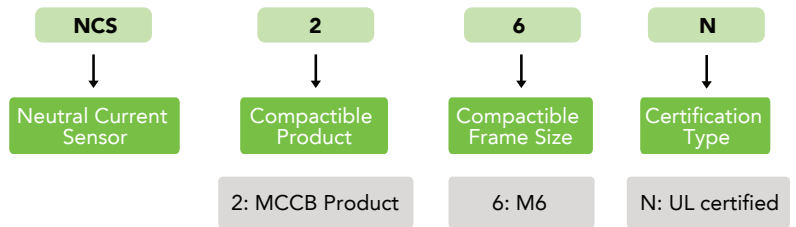
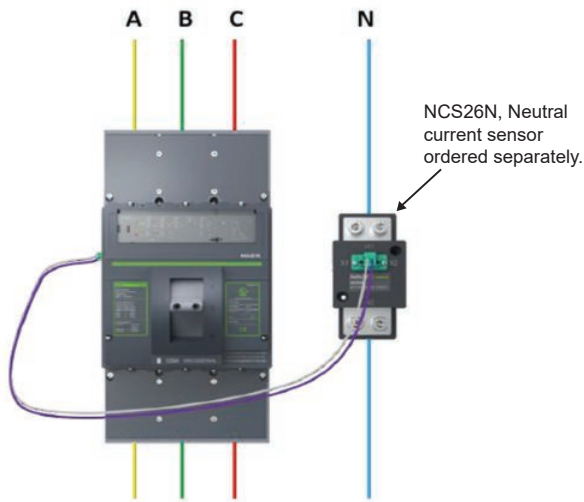

NCS26N	
Rated Operational Current (A)	800 - 1200
Induction Ratio (A-mV)	1000 : 137.5
Operational Temperature	-40°C ~ +70°C
Cable size	14 AWG ~ 24 AWG
Standards	UL489, UL1998 (Software)
Weight (kg)	1.6

Energy limiting Maintenance Switch

ELM20



ELM20 is used to mitigate arc hazards and protect personal safety during product maintenance. It is used in coordination with the Molded Case Circuit Breakers M6-3P4W with ARMS protection function.

Note: ARMS (Arc flash reduction maintenance mode settings).

ELM20	
Ambient temp (°C)	-20° ~ +70°
Atmospheric conditions of humidity and heat	Relative humidity can be up to 90% at +20° and should not exceed 50% at +40°
Pollution class	Class 3
Rated voltage Ue(V)	AC480V/DC24
Rated frequency (Hz)	50/60
Enclosure protection degree	IP40

Accessories For MCCB/MCP/MCS

External Accessories: Extended Rotary Handle

Shown: NEH2R2 handle with ES32A extended handle shaft and HM1A operating mechanism.

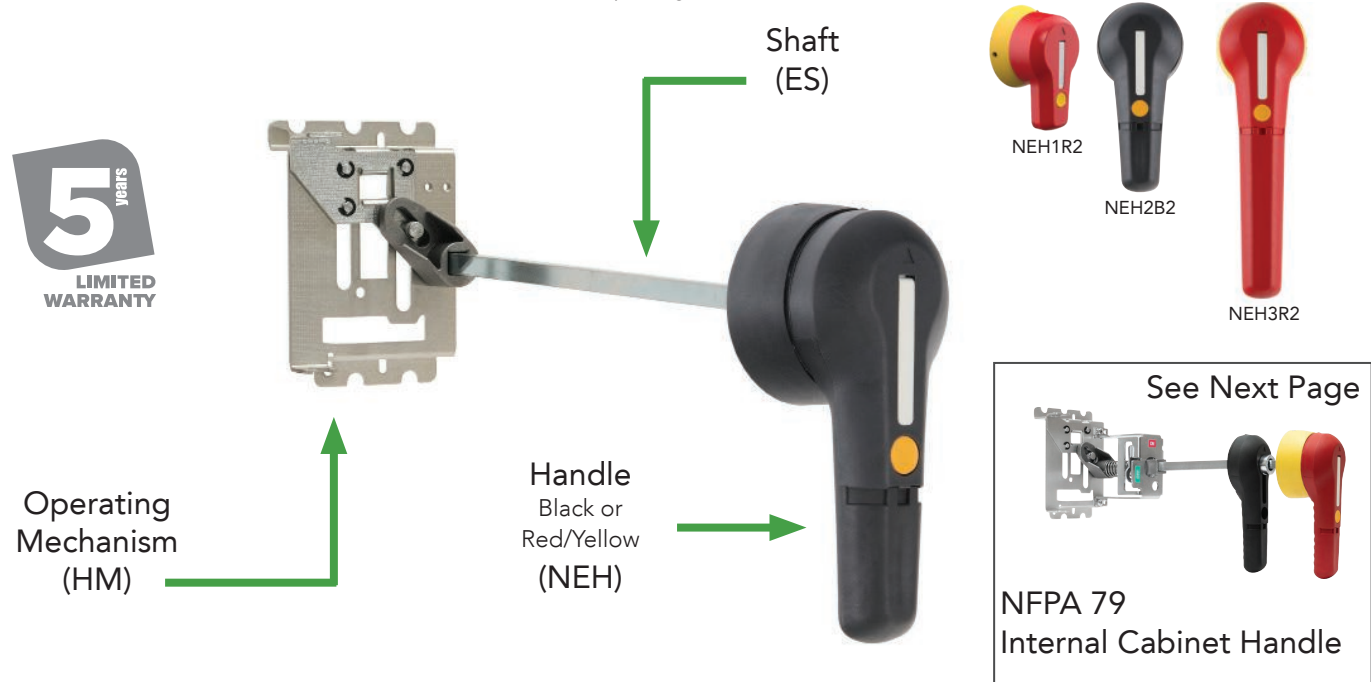

NEMA extended rotary handle mechanism selection consists of 3 components (sold separately): operating mechanism (HM), shaft (ES), and rotary handle (NEH).

- UL File Numbers E484125 and E355392

Selection Process

- Step 1.** Identify breaker frame size to select corresponding operating mechanism (HM).
- Step 2.** Select shaft (ES) based on the length needed and diameter required.
- Step 3.** Select handle (NEH) with the matching shaft diameter based on desired color combination and UL rating.

Step 1

Operating Mechanism Select One			
No of Poles	Frame Size	Use Shaft Diameter	Catalog Number
2	M1 / M2	10mm ²	HMD1A / HMD2A
	M1 / M2	10mm ²	HMD1A / HMD2A
3	M1	10mm ²	HM1A
	M2	10mm ²	HM2A
	M1	10mm ²	HM1A
	M2	10mm ²	HM2A
	M3	12mm ²	HM3B
	M4 / M5 / M6	12mm ²	HOM6B

Step 2

Shaft Select One		
Shaft Diameter	Length	Catalog Number
10mm ² M1 / M2	7.9inch (200mm)	ES20C
	12.6inch (320mm)	ES32C
	19.7inch (500mm)	ES50C
10mm ² M1 / M2	7.9inch (200mm)	ES20A
	12.6inch (320mm)	ES32A
	19.7inch (500mm)	ES50A
10mm ² M1 / M2	7.9inch (200mm)	ES20C
	12.6inch (320mm)	ES32C
	19.7inch (500mm)	ES50C
10mm ² M1 / M2	7.9inch (200mm)	ES20A
	12.6inch (320mm)	ES32A
	19.7inch (500mm)	ES50A
12mm ² M3 / M4 / M5 / M6	7.9inch (200mm)	ES20B
	12.6inch (320mm)	ES32B
	19.7inch (500mm)	ES50B

Step 3

4/4X Handle Select One			
Frame Size	Handle Size	Color	Catalog Number
M1 / M2	Short Handle	Black	NEH1B2
		Red / Yellow	NEH1R2
M1 / M2	Standard Handle	Black	NEH2B2
		Red / Yellow	NEH2R2
M1 / M2	Short Handle	Black	NEH1B2
		Red / Yellow	NEH1R2
M1 / M2	Standard Handle	Black	NEH2B2
		Red / Yellow	NEH2R2
M3 / M4 / M5 / M6	Standard Handle	Black	NEH3B2
		Red / Yellow	NEH3R2

Accessories For MCCB/MCP/MCS

External Accessories: NFPA 79 Internal Cabinet Handle

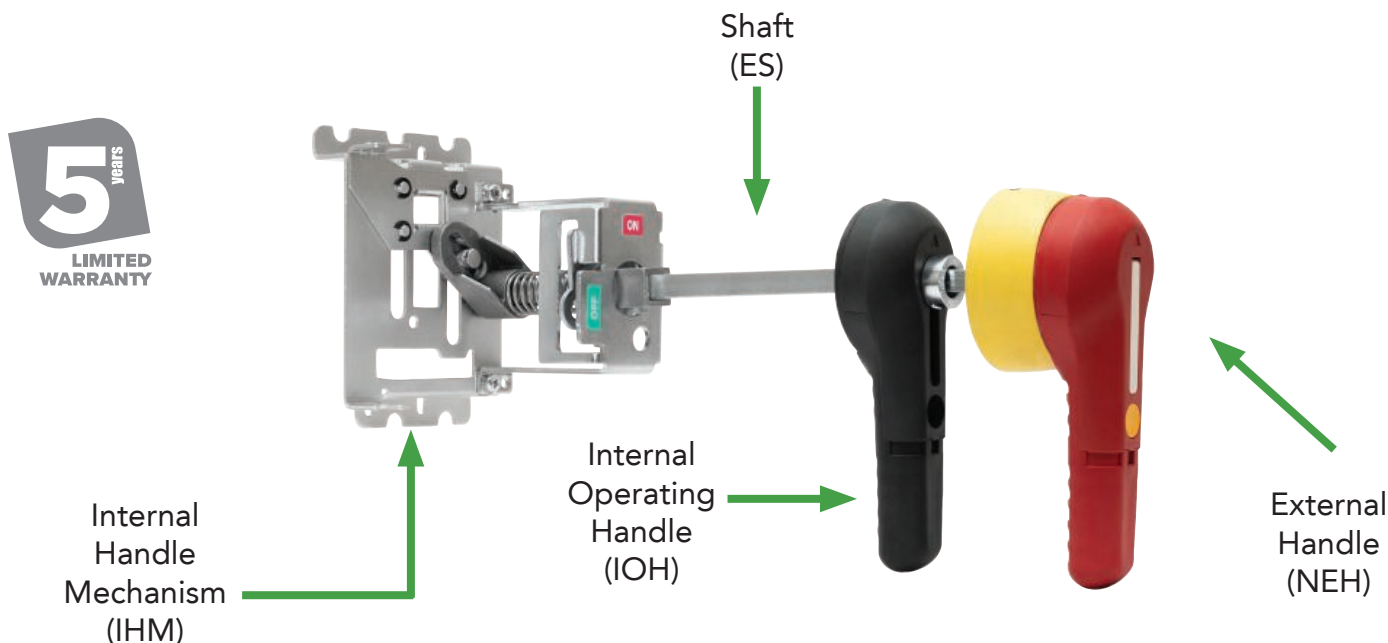

D

- UL File Numbers E484125 and E355392

Selection Process

- Step 1.** Identify breaker frame size to select corresponding internal handle mechanism (IHM).
- Step 2.** Select shaft (ES) based on the length needed and diameter required.
- Step 3.** Select the internal operating handle (IOH) based on the breaker frame size.
- Step 4.** Select handle (NEH) with the matching shaft diameter based on desired color combination and UL rating.

Step 1

Internal Handle Mechanism		
Select One		
Frame Size	Use Shaft Diameter	Catalog Number
M1	10mm ²	IHM1
M2	10mm ²	IHM2
M3	12mm ²	IHM3
M4 or M5	12mm ²	IHM4

+

Step 2

Shaft		
Select One		
Shaft Diameter	Length	Catalog Number
10mm ² M1 or M2	7.9inch (200mm)	ES20A
	12.6inch (320mm)	ES32A
	19.7inch (500mm)	ES50A
12mm ² M3, M4 or M5	7.9inch (200mm)	ES20B
	12.6inch (320mm)	ES32B
	19.7inch (500mm)	ES50B

+

Step 3

Internal Operating Handle		
Select One		
Frame Size	Use Shaft Diameter	Catalog Number
M1 or M2	10mm ²	IOH2
M3, M4 or M5	12mm ²	IOH3

+

Step 4

4/4X Handle			
Select One			
Frame Size	Use Shaft Diameter	Color	Catalog Number
M1 or M2	10mm ²	Black	NEH2B2
		Red / Yellow	NEH2R2
M3, M4 or M5	12mm ²	Black	NEH3B2
		Red / Yellow	NEH3R2

Accessories For MCCB/MCP/MCS

External Accessories: M1-M6 Flange Handle Mechanism

Green Highlight = Most Popular

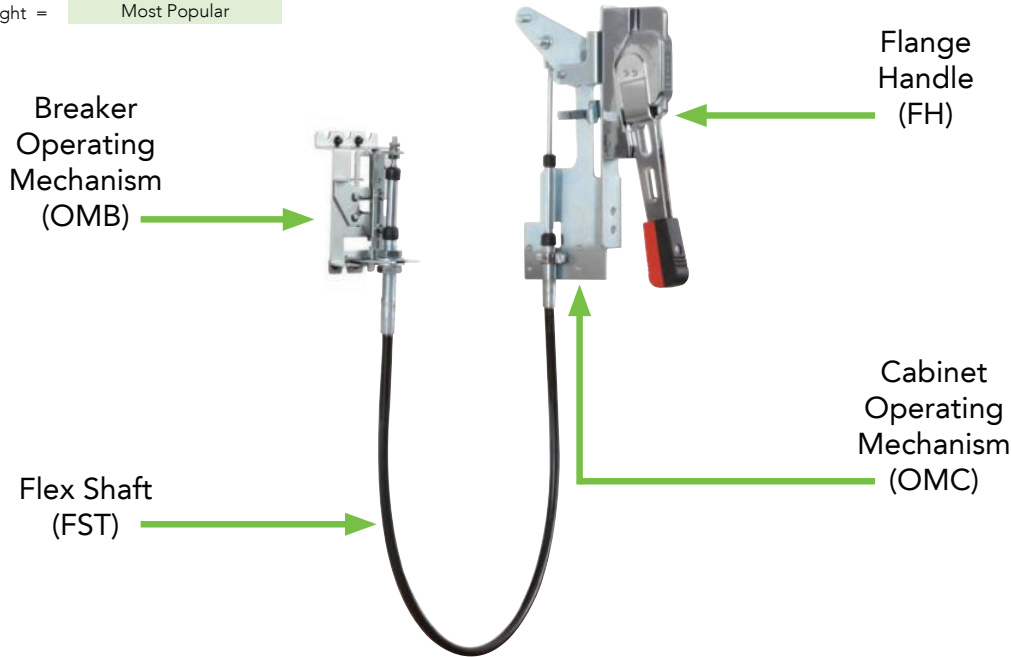

M1-M5 Flange handle mechanism selection is separated into 4 components (sold separately): flange handle (FH), flex shaft (FST), cabinet operating mechanism (OMC) and breaker operating mechanism (OMB). NOARK UL MCCB frame size: M1 (15-150A), M2 (175-250A), M3 (300-400A), M4 (500-600A), M5 (700-800A), and M6 (800-1200A).

Selection Process

- UL File Numbers E355392, E484125

- Step 1.** Select desired flange handle.
- Step 2.** Select cabinet operating mechanism.
- Step 3.** Select breaker operating mechanism based on frame size.
- Step 4.** Select flex shaft* based on enclosure requirements.

Step 1			+		Step 2		+		Step 3		+		Step 4		
Flange Handle					Cabinet Operating Mechanism				Breaker Operating Mechanism				Flex Shaft*		
Select One					Select One				Select One				Select One		
Frame Size	Handle Type / Length	Catalog Number			Frame Size	Catalog Number			Frame Size	Catalog Number			Frame Size	Length	Catalog Number
M1 / M2 / M3 / M4 / M5 / M6	Compact fixed length (9.57in) UL 4, 4X Rated	FH4XC			M1 / M2 / M3 / M4 / M5 / M6	OMC			M1	OMB21			M1 / M2 / M3 / M4 / M5	3 feet	FST3
	Adjustable length (11.81 - 13.62in) UL 4, 4X Rated	FH4XD					M2	OMB22			4 feet	FST4			
									M3	OMB23				5 feet	FST5
									M4 / M5	OMB24				6 feet	FST6
									M6	OMB26			M6	4 feet	FSB4
														5 feet	FSB5
														6 feet	FSB6
														7 feet	FSB7

* When selecting the length of shaft, ensure minimum bending radius of 6 inches is maintained to operate properly. Contact NOARK if additional lengths are needed.

Accessories For MCCB/MCP/MCS

Connection Hardware: Terminal Lugs



1-Hole

- Terminal lugs included with molded case circuit breakers standard. Listed individually for replacement purposes only.
- Sold Individually
Example: Line / Load Terminal Lugs for 3-pole breaker requires six
- UL File Number E349009

Accessory Description	Frame Size	Configuration	Specifications	Catalog Number
Terminal Lugs	M1 (150A)	1-Hole Standard	75°C #14 AWG~#3/0 AWG* (1) Cu wire #12 AWG~#3/0 AWG (1) Al wire	LTC21NAA
	M2 (250A)	1-Hole Standard	75°C #3 AWG~300kcmil (1) Cu or Al wire	LTC22NAA
	M3 (400A)	1-Hole Standard	75°C #4/0 AWG~750kcmil (1) Cu or Al wire	LTC23NAA
		2-Hole** Optional	75°C #3 AWG~250kcmil (2) Cu or Al wire	LTC23NBA
	M4 (600A)	2-Hole Standard	75°C #2/0 AWG~500kcmil (2) Cu or Al wire	LTC24NBA
	M5 (800A)	2-Hole (700A) Standard	75°C 250kcmil~600kcmil (2) Cu or Al wire	LTC25NBA
		3-Hole (800A) Standard	75°C #4/0 AWG~500kcmil (3) Cu or Al wire	LTC25NCA
	M6 (1200A)	3-Hole (800-1000A) Standard	75°C #3/0 AWG~750kcmil (3) Cu or Al wire	LTC26NCA
4-Hole (1200A) Standard		75°C #3/0 AWG~500kcmil (4) Cu or Al wire	LTC26NDA	

NOTE: At 100% rated breaker, 90°C wire are used with ampacity based on 75°C rating

** Requires external terminal cover part no. TC23NB ordered separately

* AWG = American Wire Gauge



Accessory Description	Type	Configuration	Catalog Number
Terminal Cover	M3	2-Holes	TC23NB

- Required for installation of M3 2-Hole terminal LTC23NB or LTC23NBA

D

Additional products, accessories and higher ratings available. Contact your NOARK representative or visit na.noark-electric.com for additional information.

Accessories For MCCB/MCP/MCS

Connection Hardware: Multi-wire Terminal Lug Kits



- Multi-wire terminal lug kits include: three terminal lugs and one terminal shield.
- Al/Cu rated
- UL File Number E355392

Accessory Description	Frame Size	Configuration	Specifications	Catalog Number
Multi-wire Terminal Lug Kits	M1 (150A)	3-Hole	167 °F (75 °C) #12 AWG*~#3 AWG* Al wire or #14 AWG*~#3 AWG* Cu wire	LK21NCA
		6-Hole	167 °F (75 °C) #12 AWG*~#6 AWG* Al wire or #14 AWG*~#6 AWG* Cu wire	LK21NFA
	M2 (250A)	3-Hole	167 °F (75 °C) #8 AWG*~#2/0 AWG* Al/Cu wire	LK22NCA
		3-Hole (one large, two small)	167 °F (75 °C) #3 AWG*~#2/0 AWG*, (1) Al/Cu wire and # 12 AWG*~#1 AWG*, (2) Al/Cu wire	LK22NGA
		6-Hole	167 °F (75 °C) #12 AWG*~#6 AWG Al/Cu wire	LK22NFA
	M3 (400A)	2-Hole	167 °F (75 °C) #3 AWG* ~ 250kcmil Al/Cu wire	LK23NBA
		3-Hole	167 °F (75 °C) #3 AWG* ~ 250kcmil Al/Cu wire	LK23NCA
		5-Hole (two large, three small)	167 °F (75 °C) #12 AWG*~#1 AWG*, (3) Al/Cu wire and #3 AWG*~#3/0 AWG*, (2) Al/Cu wire	LK23NEA
		6-Hole	167 °F (75 °C) 12 AWG*~#3 AWG* Al/Cu wire	LK23NFA
	M4 (600A)	2-Hole	75°C #2/0 AWG~500kcmil (2) Cu or Al wire	LK24NBA
		3-Hole	167 °F (75 °C) #2/0 AWG*~250kcmil Al/Cu wire	LK24NCA
		5-Hole	167 °F (75 °C) #12 AWG*~#1 AWG*, (3) Al/Cu wire and #3 AWG*~#3/0 AWG*, (2) Al/Cu wire	LK24NEA

* AWG = American Wire Gauge

Additional products, accessories and higher ratings available. Contact your NOARK representative or visit na.noark-electric.com for additional information.

Accessories For MCCB/MCP/MCS

Lugs to Bus Bar Conversion Kits

Frame Size	Bus Pad Dimensions (mm)										Bolt Size	Bolt Torque	Conversion Kit Catalog Number
	Line Side (Top)					Load Side (Bottom)							
	W	D	D1	C	H	W	D	D1	C	H			
M1	14.2	14.8	7.3	-	18.5	14.2	16.8	7.3	-	17.5	M6 x 16	10Nm/89 lb in	CKLB21
M2	25	18.5	8.5	-	23	25	18.1	8.5	-	21	M8 x 20	11Nm/97.4 lb in	CKLB22
M3	30	30	13.5	-	27.8	26	27	13.5	-	25.9	M10 x 30	25Nm/222lb-in	Not Required
M4	50	33.3	16.5	-	33.5	50	33	17	-	33.5	M12 x 30	30Nm/265lb-in	Not Required
M5	50	33.4	16.5	-	33.5	50	33	17	-	33.5	M12 x 30	30Nm/265lb-in	Not Required
M6	50	30	12	25	32.6	50	27.5	11.7	25	32.6	M10 x 40(2)	25Nm/222lb-in	Not Required

D

M1-M5 Breaker Bus Pad Dimensions

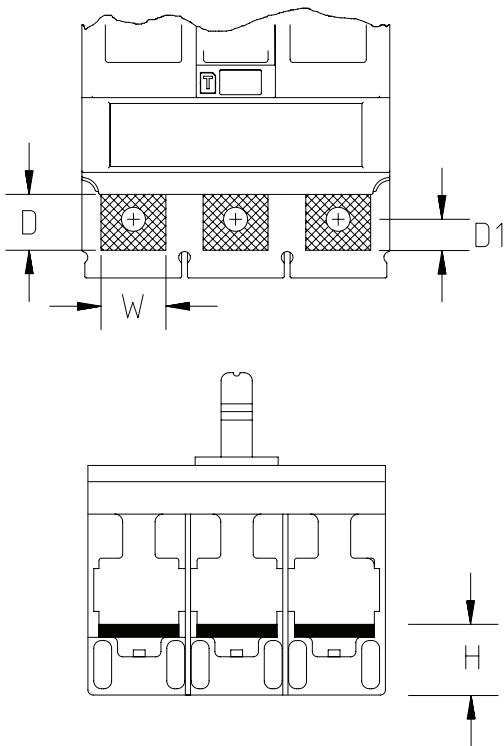

M6 Breaker Bus Pad Dimensions

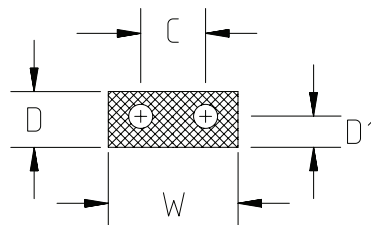

CKLB Conversion Kit



Enclosed Breakers

Overview

Features

NOARK's X Series enclosed molded case breakers combine a UL Listed enclosure with our M Series Molded Case Circuit Breakers and neutral terminals, when required for 4 wire systems. The components and assembly comply to UL489 and CSA C22.2 No.5 standards. Enclosed Breakers are used wherever a feeder or branch circuit breaker must be mounted independently. Enclosed breakers are suitable for Service Entrance as outlined in the National Electric Code and Canadian Electrical Code.

- Rated Current up to 600A*
- Voltage rating up to 600Vac
- NEMA Enclosure Type 1, 12 and 3R
- Molded Case Circuit Breakers (Ex9 M Series: M1-M4)
- Neutral terminals for 3P-4W and 2P-3W systems

Certifications

- UL 489 Listed, File No. E355392
- CSA C22.2 No. 5, File No. E355392
- EC/EN 60947-2



QR code to
Enclosed Breaker
Catalog



QR code to product
Website

*For Enclosed breaker offering above 600A and additional functions like ground fault protection and arc flash mitigation, please contact your NOARK sales representative.

Enclosed Breakers

15-150A & 175-250A Product Selection

15-150A Products

Enclosure	SCCR	Current Rating (A)	3P-4W, 1 Hole NT	3P-3W
Type 1	M1S 35kA@480V	100	E01-1AM1S100T3L	E01-XNM1S100T3L
		150	E01-1AM1S150T3L	E01-XNM1S150T3L
	M1N 65kA@480V	100	E01-1AM1N100T3L	E01-XNM1N100T3L
		150	E01-1AM1N150T3L	E01-XNM1N150T3L
	M1H 100kA@480V	100	E01-1AM1H100T3L	E01-XNM1H100T3L
		150	E01-1AM1H150T3L	E01-XNM1H150T3L
Type 12	M1S 35kA@480V	100	E12-1AM1S100T3L	E12-XNM1S100T3L
		150	E12-1AM1S150T3L	E12-XNM1S150T3L
	M1N 65kA@480V	100	E12-1AM1N100T3L	E12-XNM1N100T3L
		150	E12-1AM1N150T3L	E12-XNM1N150T3L
	M1H 100kA@480V	100	E12-1AM1H100T3L	E12-XNM1H100T3L
		150	E12-1AM1H150T3L	E12-XNM1H150T3L
Type 3R	M1S 35kA@480V	100	E3R-1AM1S100T3L	E3R-XNM1S100T3L
		150	E3R-1AM1S150T3L	E3R-XNM1S150T3L
	M1N 65kA@480V	100	E3R-1AM1N100T3L	E3R-XNM1N100T3L
		150	E3R-1AM1N150T3L	E3R-XNM1N150T3L
	M1H 100kA@480V	100	E3R-1AM1H100T3L	E3R-XNM1H100T3L
		150	E3R-1AM1H150T3L	E3R-XNM1H150T3L

E

175-250A Products

Enclosure	SCCR	Current Rating (A)	3P-4W, 1 Hole NT	3P-3W
Type 1	M2S 35kA@480V	200	E01-2AM2S200T3L	E01-XNM2S200T3L
		250	E01-2AM2S250T3L	E01-XNM2S250T3L
	M2N 65kA@480V	200	E01-2AM2N200T3L	E01-XNM2N200T3L
		250	E01-2AM2N250T3L	E01-XNM2N250T3L
	M2H 100kA@480V	200	E01-2AM2H200T3L	E01-XNM2H200T3L
		250	E01-2AM2H250T3L	E01-XNM2H250T3L
Type 12	M2S 35kA@480V	200	E12-2AM2S200T3L	E12-XNM2S200T3L
		250	E12-2AM2S250T3L	E12-XNM2S250T3L
	M2N 65kA@480V	200	E12-2AM2N200T3L	E12-XNM2N200T3L
		250	E12-2AM2N250T3L	E12-XNM2N250T3L
	M2H 100kA@480V	200	E12-2AM2H200T3L	E12-XNM2H200T3L
		250	E12-2AM2H250T3L	E12-XNM2H250T3L
Type 3R	M2S 35kA@480V	200	E3R-2AM2S200T3L	E3R-XNM2S200T3L
		250	E3R-2AM2S250T3L	E3R-XNM2S250T3L
	M2N 65kA@480V	200	E3R-2AM2N200T3L	E3R-XNM2N200T3L
		250	E3R-2AM2N250T3L	E3R-XNM2N250T3L
	M2H 100kA@480V	200	E3R-2AM2H200T3L	E3R-XNM2H200T3L
		250	E3R-2AM2H250T3L	E3R-XNM2H250T3L

Note: For more assembled products not listed here, please consult the NOARK Enclosed Breaker catalog

Enclosed Breakers

300-400A & 400-600A Product Selection

300-400A Products

Enclosure	SCCR	Current Rating (A)	3P-4W, 1 Hole NT	3P-4W, 2 Hole NT	3P-3W
Type 1	M3S 42kA@480V	300	E01-3AM3S300T3L	E01-3BM3S300T3L	E01-XNM3S300T3L
		400	E01-3AM3S400T3L	E01-3BM3S400T3L	E01-XNM3S400T3L
	M3N 65kA@480V	300	E01-3AM3N300T3L	E01-3BM3N300T3L	E01-XNM3N300T3L
		400	E01-3AM3N400T3L	E01-3BM3N400T3L	E01-XNM3N400T3L
	M3H 100kA@480V	300	E01-3AM3H300T3L	E01-3BM3H300T3L	E01-XNM3H300T3L
		400	E01-3AM3H400T3L	E01-3BM3H400T3L	E01-XNM3H400T3L
Type 12	M3S 42kA@480V	300	E12-3AM3S300T3L	E12-3BM3S300T3L	E12-XNM3S300T3L
		400	E12-3AM3S400T3L	E12-3BM3S400T3L	E12-XNM3S400T3L
	M3N 65kA@480V	300	E12-3AM3N300T3L	E12-3BM3N300T3L	E12-XNM3N300T3L
		400	E12-3AM3N400T3L	E12-3BM3N400T3L	E12-XNM3N400T3L
	M3H 100kA@480V	300	E12-3AM3H300T3L	E12-3BM3H300T3L	E12-XNM3H300T3L
		400	E12-3AM3H400T3L	E12-3BM3H400T3L	E12-XNM3H400T3L
Type 3R	M3S 42kA@480V	300	E3R-3AM3S300T3L	E3R-3BM3S300T3L	E3R-XNM3S300T3L
		400	E3R-3AM3S400T3L	E3R-3BM3S400T3L	E3R-XNM3S400T3L
	M3N 65kA@480V	300	E3R-3AM3N300T3L	E3R-3BM3N300T3L	E3R-XNM3N300T3L
		400	E3R-3AM3N400T3L	E3R-3BM3N400T3L	E3R-XNM3N400T3L
	M3H 100kA@480V	300	E3R-3AM3H300T3L	E3R-3BM3H300T3L	E3R-XNM3H300T3L
		400	E3R-3AM3H400T3L	E3R-3BM3H400T3L	E3R-XNM3H400T3L

175-250A Products

Enclosure	SCCR	Current Rating (A)	3P-4W, 2 Hole NT	3P-3W
Type 1	M4S 42kA@480V	500	E01-4BM4S500T3L	E01-XNM4S500T3L
		600	E01-4BM4S600T3L	E01-XNM4S600T3L
	M4N 65kA@480V	500	E01-4BM4N500T3L	E01-XNM4N500T3L
		600	E01-4BM4N600T3L	E01-XNM4N600T3L
	M4H 100kA@480V	500	E01-4BM4H500T3L	E01-XNM4H500T3L
		600	E01-4BM4H600T3L	E01-XNM4H600T3L
Type 12	M4S 42kA@480V	500	E12-4BM4S500T3L	E12-XNM4S500T3L
		600	E12-4BM4S600T3L	E12-XNM4S600T3L
	M4N 65kA@480V	500	E12-4BM4N500T3L	E12-XNM4N500T3L
		600	E12-4BM4N600T3L	E12-XNM4N600T3L
	M4H 100kA@480V	500	E12-4BM4H500T3L	E12-XNM4H500T3L
		600	E12-4BM4H600T3L	E12-XNM4H600T3L
Type 3R	M4S 42kA@480V	500	E3R-4BM4S500T3L	E3R-XNM4S500T3L
		600	E3R-4BM4S600T3L	E3R-XNM4S600T3L
	M4N 65kA@480V	500	E3R-4BM4N500T3L	E3R-XNM4N500T3L
		600	E3R-4BM4N600T3L	E3R-XNM4N600T3L
	M4H 100kA@480V	500	E3R-4BM4H500T3L	E3R-XNM4H500T3L
		600	E3R-4BM4H600T3L	E3R-XNM4H600T3L

Miniature Circuit Breakers

Understanding UL 489 & UL 1077 Devices

The key to understanding UL 1077 supplementary protection and UL 489 branch protection requirements is to first understand how to identify the products, the applications they can be used for and importance of selecting the correct device in compliance with UL standards and NEC Codes.

- A UL 489 device can be used as branch circuit protection or supplementary protection.
- UL 1077 devices are only acceptable for providing supplementary protection where there is branch circuit protection ahead of it.

UL 489 Circuit Breakers and Branch Circuit Overcurrent Devices

National Electrical Code (NEC) defines a branch circuit as the circuit conductors between the final overcurrent device protecting the circuit and the outlets. UL 489 opens automatically on overload and short circuit. It also protects wire and cable against overload and short circuit. UL 489 circuit breaker used for branch circuit protection.

UL 489 Applications:

- Receptacles and branch lighting
- Control Panels
- Load circuits leaving the equipment (external)
- Uninterruptible power supply (UPS)
- Relays
- Heating, ventilation, air conditioning and refrigeration equipment (HVAC/R)
- Variable frequency drives (VFD)

Features:

- DIN rail mountable
- Stand alone Branch Circuit Protection
- External handle mechanisms available
- Field mounted accessories
- Various levels of protection (curves)



F

UL 489 products have larger dimensions to provide the necessary phase to phase voltage air gap.

UL 1077 Supplementary Protectors & Overcurrent Devices

UL 1077 Supplementary Protector is a manually re-settable device designed to open the circuit automatically on a predetermined value of time versus current or voltage within an appliance or other electrical equipment. A supplementary protective device is intended to provide limited overcurrent protection for specific applications and utilization equipment such as cabinet lighting and appliances.

Example: only use UL 1077 to protect circuits inside the equipment that do not feed circuits that exit the equipment.

UL 1077 Applications:

- Cabinet Lighting
- Appliances
- Control Power Transformers
- Relays
- Control Circuits

Features:

- DIN rail mountable
- Field mounted accessories
- Various levels of protection (curves)



Disclaimer: Proper Sizing of an overcurrent protection device is the responsibility of the customer and should be determined using the application standards of the NEC*, CEC**, or other applicable standards.

Miniature Circuit Breakers

Applying UL 489 Breakers Based on Common System Voltages

Voltage 120/240V 1 Phase

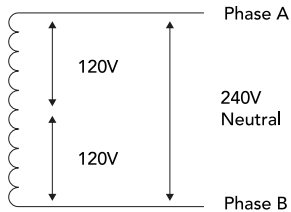

Connection		Style	Rating
Poles	Voltage		
One	120V	B1N or B1NQ	120/240V
Two	240V	B1N or B1NQ	120/240V

Voltage 208/120 3 Phase

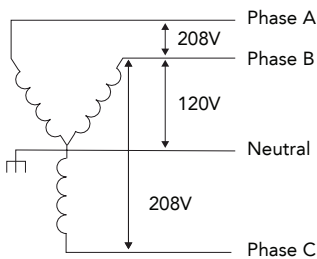

Connection		Style	Rating
Poles	Voltage		
One	120V	B1N	120/240V
Two	208V	B1N	120/240V
Three	208V	B1N	240V

Voltage 240V Delta Ungrounded

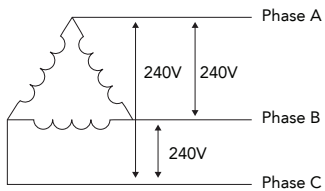

Connection		Style	Rating
Poles	Voltage		
Two	240V	B1N	240V
Three	240V	B1N	240V

Note: For high-leg delta or 480V delta systems, please call your NOARK representative.

Voltage 3 Phase 480/277V

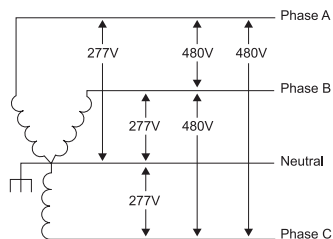

Connection		Style	Rating
Poles	Voltage		
One	277V	B1H	480/277V
Two	480V	B1H	480/277V
Three	480/277V	B1H	480/277V

Note: One can always use a higher rated breaker. (ie. B1NQ<B1N<B1H)

Disclaimer: Proper Sizing of an overcurrent protection device is the responsibility of the customer and should be determined using the application standards of the NEC*, CEC**, or other applicable standards.

Miniature Circuit Breakers

Curves

Miniature circuit breakers have different protection curves to accommodate different applications.

C Curve

In Type C curve applications, the magnetic trip is set between 5-10 times the full load current. This is the most common protection used for cables, lighting, resistive loads, general purpose applications and when properly sized, for motors.



C Curve (5-10 In)

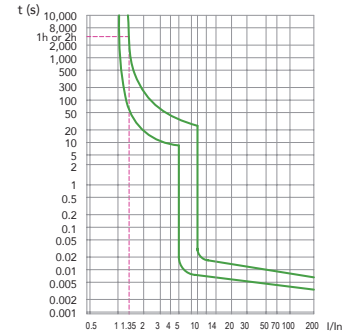

D Curve

Type D curve applications have a higher setting of 7-15 times the full load current due to the inrush current of motor loads and the magnetizing current on the primary of a transformer or solenoid. Application for this curve include motor loads, transformer primary and solenoids due to the inrush or magnetizing currents.



D Curve (10-20 In)

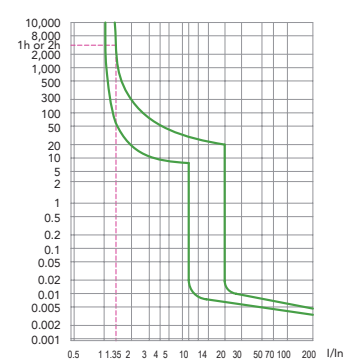

F

B Curve

Type B curves provide a magnetic trip setting of 3-5 times the full load current. Applications: electronic circuits.

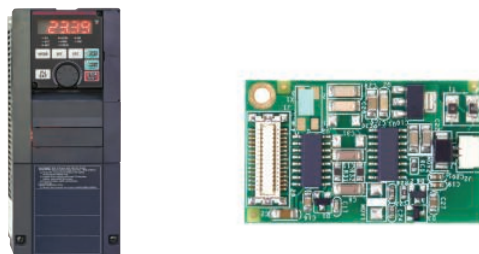

B Curve (3-5 In)

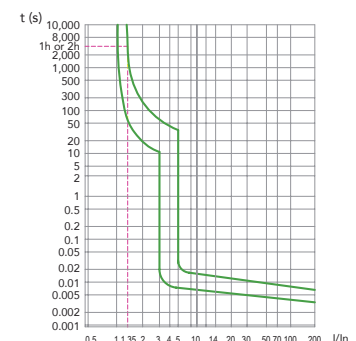

Disclaimer: Proper Sizing of an overcurrent protection device is the responsibility of the customer and should be determined using the application standards of the NEC*, CEC**, or other applicable standards.

*NEC-National Electrical Code
**CEC-Canadian Electrical Code

Miniature Circuit Breakers

UL 489 Product Overview

Features

The B1 UL 489 miniature circuit breakers are available in a complete range of amperages from 0.5A to 63A. Standard ratings of 10kA at 480Y/277Vac and 110kA at 125Vdc. These are suitable for branch circuit protection.

- Breakers mount on standard 35mm DIN rail
- Can be used in UL 1077 or CSA C22.2 No.235 applications
- Field installable shunt trip and auxiliary switch
- Available with provisions for ring tongue terminals
- Module width of only 0.71in (18mm) per pole
- Contact position indicator (red/green)
- Provision for pad locking the toggle in ON or OFF position



Typical Applications

- Branch Circuit Protection
- Receptacle and lighting circuits
- Motor control circuits
- Load circuits leaving the equipment (external)
- Heating, ventilation, air conditioning, refrigeration equipment
- Power supplies
- Control instrumentation
- Relays
- Uninterruptible power supply (UPS)
- Power conditioners

Certifications

UL 489 File Number E355392 / IEC 60947-2

- UL489 listed, File No. E355392
- CSA Standards C22.2 No. 5, File No. E355392
- IEC 60947-2 standard for industrial applications of circuit protection
- CCC China Compulsory Certification

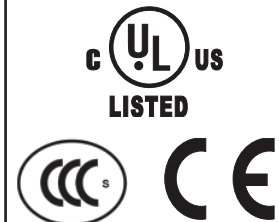

Miniature Circuit Breakers

B1N UL 489 240Vac; 60/125Vdc 10kA - Box Lugs



Rated Amperage (A)	B Curve (3-5In) Electronic		C Curve (5-10In) Standard		D Curve (10-20In) Inductive	
	1-pole - 240Vac / 60Vdc	2-pole - 240Vac / 125Vdc	1-pole - 240Vac / 60Vdc	2-pole - 240Vac / 125Vdc	1-pole - 240Vac / 60Vdc	2-pole - 240Vac / 125Vdc
	Catalog Number	Catalog Number	Catalog Number	Catalog Number	Catalog Number	Catalog Number
0.5	B1N1B0.5	B1N2B0.5	B1N1C0.5	B1N2C0.5	B1N1D0.5	B1N2D0.5
1	B1N1B1	B1N2B1	B1N1C1	B1N2C1	B1N1D1	B1N2D1
1.6	B1N1B1.6	B1N2B1.6	B1N1C1.6	B1N2C1.6	B1N1D1.6	B1N2D1.6
2	B1N1B2	B1N2B2	B1N1C2	B1N2C2	B1N1D2	B1N2D2
3	B1N1B3	B1N2B3	B1N1C3	B1N2C3	B1N1D3	B1N2D3
4	B1N1B4	B1N2B4	B1N1C4	B1N2C4	B1N1D4	B1N2D4
5	B1N1B5	B1N2B5	B1N1C5	B1N2C5	B1N1D5	B1N2D5
6	B1N1B6	B1N2B6	B1N1C6	B1N2C6	B1N1D6	B1N2D6
7	B1N1B7	B1N2B7	B1N1C7	B1N2C7	B1N1D7	B1N2D7
8	B1N1B8	B1N2B8	B1N1C8	B1N2C8	B1N1D8	B1N2D8
10	B1N1B10	B1N2B10	B1N1C10	B1N2C10	B1N1D10	B1N2D10
13	B1N1B13	B1N2B13	B1N1C13	B1N2C13	B1N1D13	B1N2D13
15	B1N1B15	B1N2B15	B1N1C15	B1N2C15	B1N1D15	B1N2D15
16	B1N1B16	B1N2B16	B1N1C16	B1N2C16	B1N1D16	B1N2D16
20	B1N1B20	B1N2B20	B1N1C20	B1N2C20	B1N1D20	B1N2D20
25	B1N1B25	B1N2B25	B1N1C25	B1N2C25	B1N1D25	B1N2D25
30	B1N1B30	B1N2B30	B1N1C30	B1N2C30	B1N1D30	B1N2D30
32	B1N1B32	B1N2B32	B1N1C32	B1N2C32	B1N1D32	B1N2D32
35	B1N1B35	B1N2B35	B1N1C35	B1N2C35	B1N1D35	B1N2D35
40	B1N1B40	B1N2B40	B1N1C40	B1N2C40	B1N1D40	B1N2D40
50	B1N1B50	B1N2B50	B1N1C50	B1N2C50	B1N1D50	B1N2D50
60	B1N1B60	B1N2B60	B1N1C60	B1N2C60	B1N1D60	B1N2D60
63	B1N1B63	B1N2B63	B1N1C63	B1N2C63	B1N1D63	B1N2D63

F

Additional products, accessories and higher ratings available. Contact your NOARK representative or visit na.noark-electric.com for additional information.

Miniature Circuit Breakers

B1N UL 489 240Vac; 10kA - Box Lugs

Certifications

IEC/EN 60947-2



Rated Amperage (A)	B Curve (3-5In) Electronic	C Curve (5-10In) Standard	D Curve (10-20In) Inductive
	3-pole - 240Vac	3-pole - 240Vac	3-pole - 240Vac
	Catalog Number	Catalog Number	Catalog Number
0.5	B1N3B0.5	B1N3C0.5	B1N3D0.5
1	B1N3B1	B1N3C1	B1N3D1
1.6	B1N3B1.6	B1N3C1.6	B1N3D1.6
2	B1N3B2	B1N3C2	B1N3D2
3	B1N3B3	B1N3C3	B1N3D3
4	B1N3B4	B1N3C4	B1N3D4
5	B1N3B5	B1N3C5	B1N3D5
6	B1N3B6	B1N3C6	B1N3D6
7	B1N3B7	B1N3C7	B1N3D7
8	B1N3B8	B1N3C8	B1N3D8
10	B1N3B10	B1N3C10	B1N3D10
13	B1N3B13	B1N3C13	B1N3D13
15	B1N3B15	B1N3C15	B1N3D15
16	B1N3B16	B1N3C16	B1N3D16
20	B1N3B20	B1N3C20	B1N3D20
25	B1N3B25	B1N3C25	B1N3D25
30	B1N3B30	B1N3C30	B1N3D30
32	B1N3B32	B1N3C32	B1N3D32
35	B1N3B35	B1N3C35	B1N3D35
40	B1N3B40	B1N3C40	B1N3D40
50	B1N3B50	B1N3C50	B1N3D50
60	B1N3B60	B1N3C60	B1N3D60
63	B1N3B63	B1N3C63	B1N3D63

Additional products, accessories and higher ratings available. Contact your NOARK representative or visit na.noark-electric.com for additional information.

Miniature Circuit Breakers

B1H UL 489 480Y/277Vac 10kA - Box Lugs

Certifications
IEC/EN 60947-2



Rated Amperage (A)	B Curve (3-5In) Electronic		C Curve (5-10In) Standard		D Curve (10-20In) Inductive	
	1-pole 277Vac	2-pole 480Y/277Vac	1-pole 277Vac	2-pole 480Y/277Vac	1-pole 277Vac	2-pole 480Y/277Vac
	Catalog Number	Catalog Number	Catalog Number	Catalog Number	Catalog Number	Catalog Number
0.5	B1H1B0.5	B1H2B0.5	B1H1C0.5	B1H2C0.5	B1H1D0.5	B1H2D0.5
1	B1H1B1	B1H2B1	B1H1C1	B1H2C1	B1H1D1	B1H2D1
1.6	B1H1B1.6	B1H2B1.6	B1H1C1.6	B1H2C1.6	B1H1D1.6	B1H2D1.6
2	B1H1B2	B1H2B2	B1H1C2	B1H2C2	B1H1D2	B1H2D2
3	B1H1B3	B1H2B3	B1H1C3	B1H2C3	B1H1D3	B1H2D3
4	B1H1B4	B1H2B4	B1H1C4	B1H2C4	B1H1D4	B1H2D4
5	B1H1B5	B1H2B5	B1H1C5	B1H2C5	B1H1D5	B1H2D5
6	B1H1B6	B1H2B6	B1H1C6	B1H2C6	B1H1D6	B1H2D6
7	B1H1B7	B1H2B7	B1H1C7	B1H2C7	B1H1D7	B1H2D7
8	B1H1B8	B1H2B8	B1H1C8	B1H2C8	B1H1D8	B1H2D8
10	B1H1B10	B1H2B10	B1H1C10	B1H2C10	B1H1D10	B1H2D10
13	B1H1B13	B1H2B13	B1H1C13	B1H2C13	B1H1D13	B1H2D13
15	B1H1B15	B1H2B15	B1H1C15	B1H2C15	B1H1D15	B1H2D15
16	B1H1B16	B1H2B16	B1H1C16	B1H2C16	B1H1D16	B1H2D16
20	B1H1B20	B1H2B20	B1H1C20	B1H2C20	B1H1D20	B1H2D20
25	B1H1B25	B1H2B25	B1H1C25	B1H2C25	B1H1D25	B1H2D25
30	B1H1B30	B1H2B30	B1H1C30	B1H2C30	B1H1D30	B1H2D30
32	B1H1B32	B1H2B32	B1H1C32	B1H2C32	B1H1D32	B1H2D32

F

Additional products, accessories and higher ratings available. Contact your NOARK representative or visit na.noark-electric.com for additional information.

Miniature Circuit Breakers

B1H UL 489 480Y/480Y/277Vac 10kA - Box Lugs



Rated Amperage (A)	B Curve (3-5 In) Electronic	C Curve (5-10 In) Standard	D Curve (10-20 In) Inductive
	3-pole 480Y/277Vac	3-pole 480Y/277Vac	3-pole 480Y/277Vac
	Catalog Number	Catalog Number	Catalog Number
0.5	B1H3B0.5	B1H3C0.5	B1H3D0.5
1	B1H3B1	B1H3C1	B1H3D1
1.6	B1H3B1.6	B1H3C1.6	B1H3D1.6
2	B1H3B2	B1H3C2	B1H3D2
3	B1H3B3	B1H3C3	B1H3D3
4	B1H3B4	B1H3C4	B1H3D4
5	B1H3B5	B1H3C5	B1H3D5
6	B1H3B6	B1H3C6	B1H3D6
7	B1H3B7	B1H3C7	B1H3D7
8	B1H3B8	B1H3C8	B1H3D8
10	B1H3B10	B1H3C10	B1H3D10
13	B1H3B13	B1H3C13	B1H3D13
15	B1H3B15	B1H3C15	B1H3D15
16	B1H3B16	B1H3C16	B1H3D16
20	B1H3B20	B1H3C20	B1H3D20
25	B1H3B25	B1H3C25	B1H3D25
30	B1H3B30	B1H3C30	B1H3D30
32	B1H3B32	B1H3C32	B1H3D32

Additional products, accessories and higher ratings available. Contact your NOARK representative or visit na.noark-electric.com for additional information.

Miniature Circuit Breakers

B1NQ UL 489 120/240Vac 10kA - Quick Connect Terminal

Certifications
IEC/EN 60947-2



Rated Amperage (A)	B Curve (3-5 In) Electronic		C Curve (5-10 In) Standard		D Curve (10-20 In) Inductive	
	1-pole - 120 / 240Vac	2-pole - 120 / 240Vac	1-pole - 120 / 240Vac	2-pole - 120 / 240Vac	1-pole - 120 / 240Vac	2-pole - 120 / 240Vac
	Catalog Number	Catalog Number	Catalog Number	Catalog Number	Catalog Number	Catalog Number
10	B1NQ1B10T	B1NQ2B10T	B1NQ1C10T	B1NQ2C10T	B1NQ1D10T	B1NQ2D10T
15	B1NQ1B15T	B1NQ2B15T	B1NQ1C15T	B1NQ2C15T	B1NQ1D15T	B1NQ2D15T
20	B1NQ1B20T	B1NQ2B20T	B1NQ1C20T	B1NQ2C20T	B1NQ1D20T	B1NQ2D20T
25	B1NQ1B25T	B1NQ2B25T	B1NQ1C25T	B1NQ2C25T	B1NQ1D25T	B1NQ2D25T
30	B1NQ1B30T	B1NQ2B30T	B1NQ1C30T	B1NQ2C30T	B1NQ1D30T	B1NQ2D30T
32	B1NQ1B32T	B1NQ2B32T	B1NQ1C32T	B1NQ2C32T	B1NQ1D32T	B1NQ2D32T
35	B1NQ1B35T	B1NQ2B35T	B1NQ1C35T	B1NQ2C35T	B1NQ1D35T	B1NQ2D35T
40	B1NQ1B40T	B1NQ2B40T	B1NQ1C40T	B1NQ2C40T	B1NQ1D40T	B1NQ2D40T
45	B1NQ1B45T	B1NQ2B45T	B1NQ1C45T	B1NQ2C45T	B1NQ1D45T	B1NQ2D45T
50	B1NQ1B50T	B1NQ2B50T	B1NQ1C50T	B1NQ2C50T	B1NQ1D50T	B1NQ2D50T
60	B1NQ1B60T	B1NQ2B60T	B1NQ1C60T	B1NQ2C60T	B1NQ1D60T	B1NQ2D60T
63	B1NQ1B63T	B1NQ2B63T	B1NQ1C63T	B1NQ2C63T	B1NQ1D63T	B1NQ2D63T

F



Accessory Description	Catalog Number
Flush Mount Clip (B1NQ only) - 1-pole*	FMC31N

* Note: This accessory is not compatible with comb bus bar applications. They cannot be used on miniature circuit breakers when utilizing a comb bus bar.

Additional products, accessories and higher ratings available. Contact your NOARK representative or visit na.noark-electric.com for additional information.

Miniature Circuit Breakers

UL 489 Technical Data

		B1N			B1H			B1NQ		
Conformed Standard		UL 489								
Number of Poles		1	2	3	1	2	3	1	2	
Rated Operational Voltage (V)		240Vac 60Vdc	240Vac 125Vdc	240Vac	480Y/277Vac			120/240Vac		
Rated Frequency (Hz)		50/60								
Rated Current (A)		0.5-63			0.5-32			1-63		
Instantaneous Tripping Type		B (3-5 In), C (5-10 In), D (10-20 In)								
Interrupting (kA)	120Vac	10	-	-	10	-	-	10	-	
	240Vac	10			10	10		10		
	277Vac	-			-	10		-		
	480Y/277Vac	-			-	-		-		
	60Vdc	10	10	-	-			-		
	125Vdc	-	10	-	-			-		
Inverse Time-Delay Over-Current Release Type		Thermal-Magnetic								
Service Life	Electrical	10,000						6,000		
	Mechanical	20,000						10,000		
Protection Degree		IP20								
Wire AWG	Single Wire	18-4								
	Two Wires	#18-6 / #14-10								
Operating Temperature Range		-22 °F to 167 °F (-30 °C to +75 °C)								
Insulation Coordination	Rated Insulation Voltage (Vac)	500								
	Rated Impulse Withstand Voltage (kV)	6								
Pollution Degree		Class III								
Over Voltage Category		Class III								
Mounting		35 mm DIN rail / Flush and surface mount available on B1NQ with the use of additional mounting clips								
Altitude ft (m)		<6,561 (2,000)								
Atmospheric Conditions		At 68 °F (+20), the relative humidity does not exceed 90% At 104 °F (+40), the relative humidity does not exceed 50%								

* AWG = American Wire Gauge

Miniature Circuit Breakers

UL 489 Accessories



Accessory Description	Auxiliary Contact	Catalog Number
Alarm Switch*	1NO+1NC	AL3111N
Auxiliary Contact*	1NO+1NC	AX3111N

		Alarm Switch	Auxiliary Contact
		AL	AX
Ratings (50/60Hz)	Vac	480/277V (3A) 240V (6A)	
	Vdc	250V (0.5A) 125V (1A) 24V (6A)	

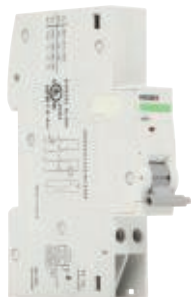

Accessory Description	Voltage Ratings	Auxiliary Contact	Catalog Number
Shunt Trip*	12-24Vac/dc	-	SHT31NC
	48-60Vac/dc	-	SHT31NB
	110-415Vac/110-130Vdc	-	SHT31NA
	12-24Vac/dc	1NO+1NC	SHT3111NC
	48-60Vac/dc	1NO+1NC	SHT3111NB
	110-415Vac/110-130Vdc	1NO+1NC	SHT3111NA
Under-Voltage Trip*	240Vac	1NC	UVT3101NA
	48Vac/dc	1NC	UVT3101NB
	120Vac	1NC	UVT3101NC
	240Vac	1NO	UVT3110NA
	48Vac/dc	1NO	UVT3110NB
	120Vac	1NO	UVT3110NC
	240Vac	-	UVT31NA
	48Vac/dc	-	UVT31NB
	120Vac	-	UVT31NC



Accessory Description	Catalog Number
Padlock* (Lock Off)	LK31N



Accessory Description	Catalog Number
Surface Mount Clip - 1-pole*	SMC311N
Surface Mount Clip - 2-pole*	SMC312N



Accessory Description	Catalog Number
35mm DIN rail	TH35A75

* Note: These accessories are not compatible with comb bus bar.

Additional products, accessories and higher ratings available. Contact your NOARK representative or visit na.noark-electric.com for additional information.

F

Miniature Circuit Breakers

UL 489 Accessories: Comb Bus Bar Specifications

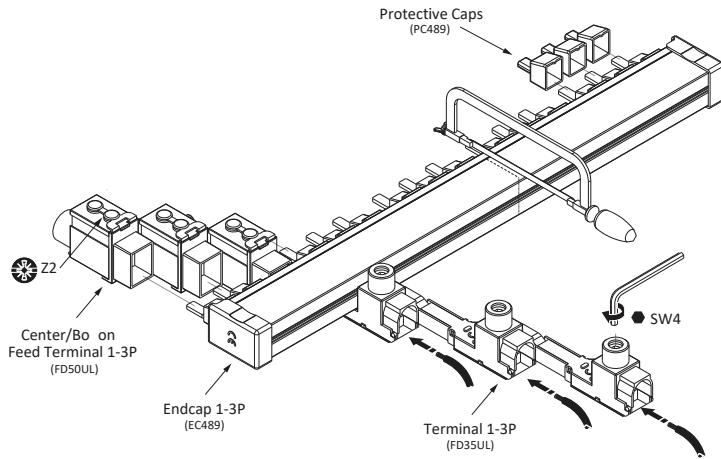

	Phase	No. of Pins	No. of Circuit Breakers	Poles	Cross Section	Rating	Catalog Number
UL 489	1	6	6x	6x	25mm ²	100A (End Feed) 115A (Center Feed)	CBA1P06P25
	1	12	12x	12x			CBA1P12P25
	1	18	18x	18x			CBA1P18P25
	1	57	57x	57x			CBA1P57P25
	2	6	3x	3x			CBA2P06P25
	2	12	6x	6x			CBA2P12P25
	2	18	9x	9x			CBA2P18P25
	2	56	28x	28x			CBA2P56P25
	3	6	2x	2x			CBA3P06P25
	3	12	4x	4x			CBA3P12P25
	3	18	6x	6x			CBA3P18P25
	3	57	19x	19x			CBA3P57P25

Description	Catalog Number
Top Feed Terminal (35mm ²)	FDA35
Bottom Feed Terminal (50mm ²)	FDA50
End Cap 1-3P	ECA25
Protective Cap	FCA25

* Note: 10kA Fuse Class J, 115A

Additional products, accessories and higher ratings available. Contact your NOARK representative or visit na.noark-electric.com for additional information.

Supplementary Protectors

UL 1077 Product Overview

Features

The B1E UL 1077 miniature circuit breaker has a complete range of amperages from 1A to 125A. Standard ratings of 5 kA at 480Y/277Vac and 10kA at 240Vac. These are suitable for supplementary protection.

- Breakers mount on standard 35mm DIN rail
- Thermal-magnetic overcurrent protection – three levels of protection, categorized by B, C and D curves
- Fulfills UL 1077, IEC 60947-2 standard
- Field-installable shunt trip and auxiliary switch up to 63A
- Module width of only 0.71in (18 mm) per pole
- Contact position indicator (red/green)
- 5-Year limited warranty



F

Typical Application

- Supplementary protection control circuits
- Cabinet lighting
- Business equipment
- Appliances

Certifications

UL 1077 No. E355391 / IEC 60947-2

- Supplementary Protectors are UL Recognized for use in the United States in accordance with NFPA® 70 (NEC).
- UL1077 Recognized Component, File No. E355391
- CSA Standards C22.2 No. 235, File No. E355391
- These devices are for international and domestic use, and also comply with IEC 60947-2 and are CE marked.



Supplementary Protectors

B1E 1-63 Amperes UL 1077 480Y/277Vac

Certifications
IEC/EN 60947-2
CE **UL** **US**



Rated Amperage (A)	B Curve (3-5 In) (Electronic)		
	1-pole - 277Vac	2-pole - 480Vac	3-pole - 480Vac
	Catalog Number	Catalog Number	Catalog Number
1	B1E1B1	B1E2B1	B1E3B1
1.6	B1E1B1.6	B1E2B1.6	B1E3B1.6
2	B1E1B2	B1E2B2	B1E3B2
3	B1E1B3	B1E2B3	B1E3B3
4	B1E1B4	B1E2B4	B1E3B4
5	B1E1B5	B1E2B5	B1E3B5
6	B1E1B6	B1E2B6	B1E3B6
8	B1E1B8	B1E2B8	B1E3B8
10	B1E1B10	B1E2B10	B1E3B10
13	B1E1B13	B1E2B13	B1E3B13
15	B1E1B15	B1E2B15	B1E3B15
16	B1E1B16	B1E2B16	B1E3B16
20	B1E1B20	B1E2B20	B1E3B20
25	B1E1B25	B1E2B25	B1E3B25
30	B1E1B30	B1E2B30	B1E3B30
32	B1E1B32	B1E2B32	B1E3B32
35	B1E1B35	B1E2B35	B1E3B35
40	B1E1B40	B1E2B40	B1E3B40
50	B1E1B50	B1E2B50	B1E3B50
60	B1E1B60	B1E2B60	B1E3B60
63	B1E1B63	B1E2B63	B1E3B63

Rated Amperage (A)	C Curve (5-10 In) (General)		
	1-pole - 277Vac	2-pole - 480Vac	3-pole - 480Vac
	Catalog Number	Catalog Number	Catalog Number
1	B1E1C1	B1E2C1	B1E3C1
1.6	B1E1C1.6	B1E2C1.6	B1E3C1.6
2	B1E1C2	B1E2C2	B1E3C2
3	B1E1C3	B1E2C3	B1E3C3
4	B1E1C4	B1E2C4	B1E3C4
5	B1E1C5	B1E2C5	B1E3C5
6	B1E1C6	B1E2C6	B1E3C6
8	B1E1C8	B1E2C8	B1E3C8
10	B1E1C10	B1E2C10	B1E3C10
13	B1E1C13	B1E2C13	B1E3C13
15	B1E1C15	B1E2C15	B1E3C15
16	B1E1C16	B1E2C16	B1E3C16
20	B1E1C20	B1E2C20	B1E3C20
25	B1E1C25	B1E2C25	B1E3C25
30	B1E1C30	B1E2C30	B1E3C30
32	B1E1C32	B1E2C32	B1E3C32
35	B1E1C35	B1E2C35	B1E3C35
40	B1E1C40	B1E2C40	B1E3C40
50	B1E1C50	B1E2C50	B1E3C50
60	B1E1C60	B1E2C60	B1E3C60
63	B1E1C63	B1E2C63	B1E3C63

Additional products, accessories and higher ratings available. Contact your NOARK representative or visit na.noark-electric.com for additional information.

Supplementary Protectors

B1E 1-125 Amperes UL 1077 480Y/277Vac

Certifications
IEC/EN 60947-2



Rated Amperage (A)	D Curve (10-20 In) (Inductive)		
	1-pole - 277Vac	2-pole - 480Vac	3-pole - 480Vac
	Catalog Number	Catalog Number	Catalog Number
1	B1E1D1	B1E2D1	B1E3D1
1.6	B1E1D1.6	B1E2D1.6	B1E3D1.6
2	B1E1D2	B1E2D2	B1E3D2
3	B1E1D3	B1E2D3	B1E3D3
4	B1E1D4	B1E2D4	B1E3D4
5	B1E1D5	B1E2D5	B1E3D5
6	B1E1D6	B1E2D6	B1E3D6
8	B1E1D8	B1E2D8	B1E3D8
10	B1E1D10	B1E2D10	B1E3D10
13	B1E1D13	B1E2D13	B1E3D13
15	B1E1D15	B1E2D15	B1E3D15
16	B1E1D16	B1E2D16	B1E3D16
20	B1E1D20	B1E2D20	B1E3D20
25	B1E1D25	B1E2D25	B1E3D25
30	B1E1D30	B1E2D30	B1E3D30
32	B1E1D32	B1E2D32	B1E3D32
35	B1E1D35	B1E2D35	B1E3D35
40	B1E1D40	B1E2D40	B1E3D40
50	B1E1D50	B1E2D50	B1E3D50
60	B1E1D60	B1E2D60	B1E3D60
63	B1E1D63	B1E2D63	B1E3D63

F



Rated Amperage (A)	1-pole	2-pole	3-pole
	Catalog Number	Catalog Number	Catalog Number
80	B1E1P80	B1E2P80	B1E3P80
100	B1E1P100	B1E2P100	B1E3P100
125	B1E1P125	B1E2P125	B1E3P125

Additional products, accessories and higher ratings available. Contact your NOARK representative or visit na.noark-electric.com for additional information.

Supplementary Protectors

UL 1077 B1E Technical Data

		B1E 1-63A			B1E 80-125A		
Conformed Standard		UL 1077					
Rated Operational Voltage (V)		480Y/277Vac; 60/125Vdc			480Y/277Vac, 110/220Vdc		
Rated Frequency (Hz)		50/60					
Rated Current (A)		1-63			80-125		
Number of Poles		1	2	3	1	2	3
Instantaneous Tripping Type		B (3-5 In), C (5-10 In), D (10-20 In)			(8-12 In)		
Interrupting (kA)	120Vac	10	-		5	-	
	120/240Vac	-					
	208Vac	-					
	240Vac	10					
	277Vac	5	-				
	480/277Vac	-	5		-	5	
	60Vdc	10	-		10	-	
	110Vdc				10	10	
	125Vdc	-	10	-		-	
220Vdc	-			10	-		
Inverse Time-Delay Over-Current Release Type		Thermal-Magnetic					
Service Life	Electrical	6,000			1,500 (80-100A) 1,000 (125A)		
	Mechanical	20,000			8,000 (80-100A) 7,000 (125A)		
Protection Degree		IP20					
Wire AWG*		#18-4			#4-1/0		
Operating Temperature Range		-22°F to 167°F (-30°C to +75°C)					
Insulation Coordination	Rated Insulation Voltage (Vac)	500					
	Rated Impulse Withstand Voltage (kV)	6			8		
Pollution Degree		Class III					
Over Voltage Category / Mounting		Class III / 35mm DIN rail					
Altitude ft (m)		<6,561 (2,000)					
Atmospheric Conditions		At 68°F (+20), the relative humidity does not exceed 90% At 104°F (+40), the relative humidity does not exceed 50%					

* AWG = American Wire Gauge

Supplementary Protectors

UL 1077 Accessories: Alarm Switch, Auxiliary Contact



Accessory Description	Catalog Number	
	1-63A	80-125A
Alarm Switch*	AL3111U	AL3111L
Auxiliary Contact*	AX3111U	AX3111L

		Alarm Contact	Auxiliary Contact
		AL	AX
Ratings (50/60Hz)	Vac	480 (3A) 277 (3A) 240 (6A)	
	Vdc	250 (0.5A) 125 (1A) 48 (2A) 24 (6A)	

F

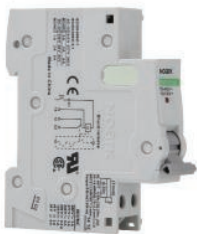

Accessory Description	Rated Voltage	Auxiliary Contact	Catalog Number	
			1-63A	80-125A
Shunt Trip*	12-24Vac/dc		SHT31UC	
	48-60Vac/dc		SHT31UB	
	110-415Vac/110-130 Vdc		SHT31UA	
	12-24Vac/dc	1NO+1NC	SHT3111UC	
	48-60Vac/dc	1NO+1NC	SHT3111UB	
	110-415Vac/110-130 Vdc	1NO+1NC	SHT3111UA	
	240-415Vac	1NO+1NC		SHT3111LA
24-48Vac/dc	1NO+1NC		SHT3111LB	
Under-Voltage Trip*	240Vac	1NC	UVT3101UA	
	48Vac/dc	1NC	UVT3101UB	
	120Vac	1NC	UVT3101UC	
	240Vac	1NO	UVT3110UA	
	48Vac/dc	1NO	UVT3110UB	
	120Vac	1NO	UVT3110UC	
	240Vac	-	UVT31UA	
	48Vac/dc	-	UVT31UB	
	120Vac	-	UVT31UC	
240Vac	-		UVT31L	

* Note: These accessories are not compatible with comb bus bar.

Additional products, accessories and higher ratings available. Contact your NOARK representative or visit na.noark-electric.com for additional information.

Supplementary Protectors

UL 1077 Accessories: Comb Bus Bar

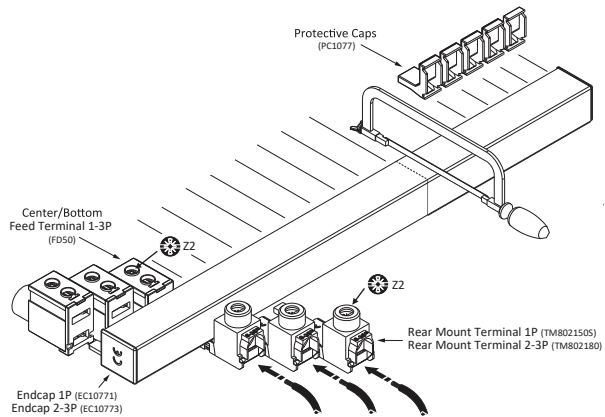

Description	Poles	Cross Section	Catalog Number
Top Feed Terminal*	1	35mm	TM802150S
	2/3	35mm	TM802180
Bottom Feed Terminal*	-	50mm	FD50
End Cap*	1	-	EC10771
	2/3	-	EC10773
Protective Cap*	-	-	PC1077

* Sold in multiples of 10.

Example: PC1077 order quantities of 10, 20, 30, 40 etc.

UL 1077	Phase	No. of Pins	No. of Circuit Breakers	Poles	Cross Section	Rating	Catalog Number
	1	6	6	1	25mm	100 amp (End Feed) 200 amp (Center Feed)	CBB1P06P25
	1	12	12	1			CBB1P12P25
	1	18	18	1			CBB1P18P25
	1	57	57	1			CBB1P57P25
	2	6	3	2			CBB2P06P25
	2	12	6	2			CBB2P12P25
	2	18	9	2			CBB2P18P25
	2	56	28	2			CBB2P56P25
	3	6	2	3			CBB3P06P25
	3	12	4	3			CBB3P12P25
	3	18	6	3			CBB3P18P25
3	57	19	3	CBB3P57P25			

Comb Bus Bar Specifications			UL 1077	
			1-pole	2 & 3-pole
Voltage Ratings	Maximum AC Voltage (Vac)		600	
	Maximum DC Voltage (Vdc)		1,000	600
Current Ratings	Maximum Current 25 mm ² Cross Sections (A)	End Feed	100	
		Center Feed	200	
Protection Class			IP20	
J Fuse Rating (kA)			10	

Additional products, accessories and higher ratings available. Contact your NOARK representative or visit na.noark-electric.com for additional information.

U4 Surge Protective Devices

Product Overview

Features

U4 surge protective devices are suitable for AC 50/60Hz, rated voltage is not more than 600V low-voltage power supply system, used to suppress the transient overvoltage is lower than the equipment impulse overvoltage, discharge the surge energy, to protect the system circuit and equipment.

- Indication window of fault status makes the product more safer to use.
- Pluggable module installation makes maintenance and replacement more convenient.
- Signal contact is optional, makes remote indication more flexible.



Standards

- UL1449 CSA C22.2 NO.269.5-17
- IEC/EN 61643-11 GB/T18802.1



Certifications

- UL CE CQC ROHS



U4 Surge Protective Devices

Product Selection

No. of Poles	MCOV (V)	With Signal Contact		Without Signal Contact	
		Catalog Number	Description	Catalog Number	Description
1P	175	U41P40175S	U4 SPD 1P 40kA 175V AC w/signal contact	U41P40175	U4 SPD 1P 40kA 175V AC UL
	320	U41P40320S	U4 SPD 1P 40kA 320V AC w/signal contact	U41P40320	U4 SPD 1P 40kA 320V AC UL
	440	U41P40440S	U4 SPD 1P 40kA 440V AC w/signal contact	U41P40440	U4 SPD 1P 40kA 440V AC UL
	550	U41P40550S	U4 SPD 1P 40kA 550V AC w/signal contact	U41P40550	U4 SPD 1P 40kA 550V AC UL
	660	U41P40660S	U4 SPD 1P 40kA 660V AC w/signal contact	U41P40660	U4 SPD 1P 40kA 660V AC UL
1P+N	175	U41N40175S	U4 SPD 1P+N 40kA 175V AC w/signal contact	U41N40175	U4 SPD 1P+N 40kA 175V AC UL
	320	U41N40320S	U4 SPD 1P+N 40kA 320V AC w/signal contact	U41N40320	U4 SPD 1P+N 40kA 320V AC UL
	440	U41N40440S	U4 SPD 1P+N 40kA 440V AC w/signal contact	U41N40440	U4 SPD 1P+N 40kA 440V AC UL
	550	U41N40550S	U4 SPD 1P+N 40kA 550V AC w/signal contact	U41N40550	U4 SPD 1P+N 40kA 550V AC UL
	660	U41N40660S	U4 SPD 1P+N 40kA 660V AC w/signal contact	U41N40660	U4 SPD 1P+N 40kA 660V AC UL
2P	175	U42P40175S	U4 SPD 2P 40kA 175V AC w/signal contact	U42P40175	U4 SPD 2P 40kA 175V AC UL
	320	U42P40320S	U4 SPD 2P 40kA 320V AC w/signal contact	U42P40320	U4 SPD 2P 40kA 320V AC UL
	440	U42P40440S	U4 SPD 2P 40kA 440V AC w/signal contact	U42P40440	U4 SPD 2P 40kA 440V AC UL
	550	U42P40550S	U4 SPD 2P 40kA 550V AC w/signal contact	U42P40550	U4 SPD 2P 40kA 550V AC UL
	660	U42P40660S	U4 SPD 2P 40kA 660V AC w/signal contact	U42P40660	U4 SPD 2P 40kA 660V AC UL
2P+N	175	U42N40175S	U4 SPD 2N40kA 175V AC w/signal contact	U42N40175	U4 SPD 2N40kA 175V AC UL
	320	U42N40320S	U4 SPD 2N40kA 320V AC w/signal contact	U42N40320	U4 SPD 2N40kA 320V AC UL
	440	U42N40440S	U4 SPD 2N40kA 440V AC w/signal contact	U42N40440	U4 SPD 2N40kA 440V AC UL
	550	U42N40550S	U4 SPD 2N40kA 550V AC w/signal contact	U42N40550	U4 SPD 2N40kA 550V AC UL
	660	U42N40660S	U4 SPD 2N40kA 660V AC w/signal contact	U42N40660	U4 SPD 2N40kA 660V AC UL
3P	175	U43P40175S	U4 SPD 3P 40kA 175V AC w/signal contact	U43P40175	U4 SPD 3P 40kA 175V AC UL
	320	U43P40320S	U4 SPD 3P 40kA 320V AC w/signal contact	U43P40320	U4 SPD 3P 40kA 320V AC UL
	440	U43P40440S	U4 SPD 3P 40kA 440V AC w/signal contact	U43P40440	U4 SPD 3P 40kA 440V AC UL
	550	U43P40550S	U4 SPD 3P 40kA 550V AC w/signal contact	U43P40550	U4 SPD 3P 40kA 550V AC UL
	660	U43P40660S	U4 SPD 3P 40kA 660V AC w/signal contact	U43P40660	U4 SPD 3P 40kA 660V AC UL
3P+N	175	U43N40175S	U4 SPD 3P+N 40kA 175V AC w/signal contact	U43N40175	U4 SPD 3P+N 40kA 175V AC UL
	320	U43N40320S	U4 SPD 3P+N 40kA 320V AC w/signal contact	U43N40320	U4 SPD 3P+N 40kA 320V AC UL
	440	U43N40440S	U4 SPD 3P+N 40kA 440V AC w/signal contact	U43N40440	U4 SPD 3P+N 40kA 440V AC UL
	550	U43N40550S	U4 SPD 3P+N 40kA 550V AC w/signal contact	U43N40550	U4 SPD 3P+N 40kA 550V AC UL
	660	U43N40660S	U4 SPD 3P+N 40kA 660V AC w/signal contact	U43N40660	U4 SPD 3P+N 40kA 660V AC UL
4P	175	U44P40175S	U4 SPD 4P 40kA 175V AC w/signal contact	U44P40175	U4 SPD 4P 40kA 175V AC UL
	320	U44P40320S	U4 SPD 4P 40kA 320V AC w/signal contact	U44P40320	U4 SPD 4P 40kA 320V AC UL
	440	U44P40440S	U4 SPD 4P 40kA 440V AC w/signal contact	U44P40440	U4 SPD 4P 40kA 440V AC UL
	550	U44P40550S	U4 SPD 4P 40kA 550V AC w/signal contact	U44P40550	U4 SPD 4P 40kA 550V AC UL
	660	U44P40660S	U4 SPD 4P 40kA 660V AC w/signal contact	U44P40660	U4 SPD 4P 40kA 660V AC UL

No. of Poles	MCOV (V)	Modules	
		Catalog Number	Description
1P	175	U41P40175M	U4 SPD 1P 40kA 175V AC Module UL
	320	U41P40320M	U4 SPD 1P 40kA 320V AC Module UL
	440	U41P40440M	U4 SPD 1P 40kA 440V AC Module UL
	550	U41P40550M	U4 SPD 1P 40kA 550V AC Module UL
	660	U41P40660M	U4 SPD 1P 40kA 660V AC Module UL

*MCOV - maximum continuous operating voltage

U4 Surge Protective Devices

Technical Data

Electrical Parameters	UL
Product Model	U4
Standards	UL1449, CSA C22.2 NO.269.5-17
Rated operating frequency	50/60Hz
Application type	Type 4CA
Poles	1P/1P+N/2P/2P+N/3P/3P+N/4P
Voltage system	120/208V, 120/240V, 277/480V, 347/600V, 400/690V
Maximum continuous operating voltage MCOV	L-N: 175/320/440/550/660V; N-PE: 255V
Nominal discharge current In	L-N: 20kA (8/20us); N-PE: 20kA (8/20us)
Measured limiting voltage MLV	L-N: 1.02/1.54/1.97/2.36/2.49kV; N-PE:1.37kV
Protection mode	L-L/L-N/L-G/N-G
Thermal protection	Yes

Mechanical Characteristics		G
Status Indication	Green = OK, Red = Fault	
Pluggable Cartridges	Yes	
Housing Material	Thermoplastic UL 94	
Flame retardant rating	V0	
Mounting method	DIN rail	
Wire range	Solid wire: #10-4 AWG (2.5~25mm ²) Strained wire: #14-8 AWG (2.5~16mm ²)	
Wiring torque	1.8lb-in (2.0Nm)	
Signal contact	Optional accessory for telecontacts	
Operating temperature	-40~+80°C	
Protection class	IP20	
Signal Contact		
Contact type	Dry contact	
Operating voltage/current	250V/1.5A; 125V//3A	
Terminal torque	28-16 AWG (0.5~1.5mm ²)	

F30 Series Fuse Holder

Product Overview

Features

F30 series Fuse holder can be used in variety of scenarios: F30M and F30CC series can be used in the conventional electrical field, while F30P series is dedicated to the photovoltaic industry. F30 series is matched with a variety of fuses and has a high interrupting capacity.

- Rated current up to 30A
- The interrupting capacity of F30M series and F30CC series is up to 200kA while F30P is 50kA.
- Available option for blown-fuse indicating light, which is convenient for quick inspection and identification.



Certifications:

- F30M:
 - UL 4248-1 Listed, File no. E530645
 - CSA Standard C22.2 No. 4248, File no. E530645
- F30CC:
 - UL 4248-4 Listed File no. E530645
 - CSA Standard C22.2 No. 4248, File no. E530645
- F30P:
 - UL4248-19 Listed. File no. E522691
 - CSA Standard C22.2 No.4248, File no. E522691



Additional products, accessories and higher ratings available. Contact your NOARK representative or visit na.noark-electric.com for additional information.

F30 Series Fuse Holder

Product Selection

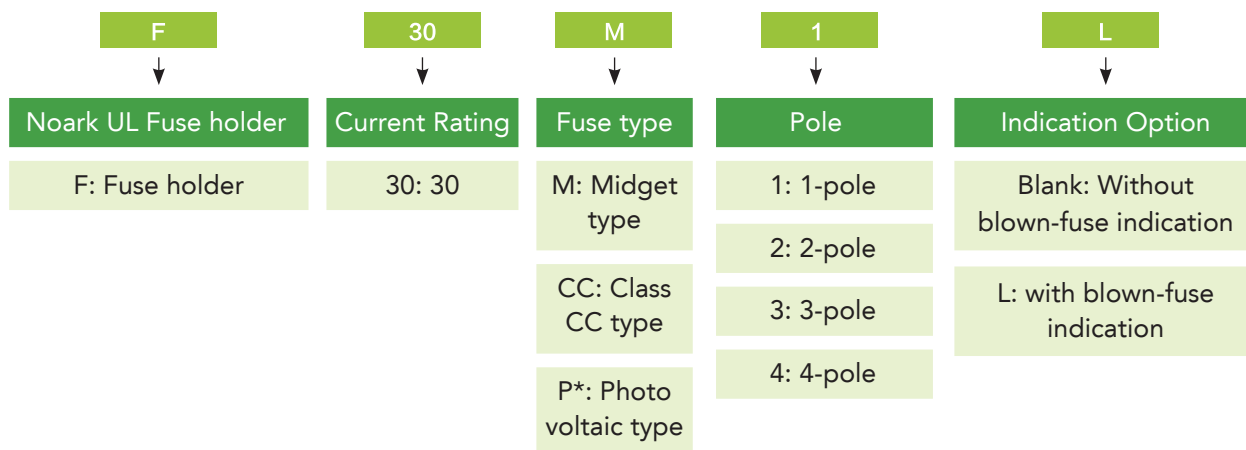

*P type available only in 1P & 2P.

Part Number	Catalog number	Description
1002561	F30M1L	1-pole Fuse holder for UL Midget with indication light
1002562	F30M2L	2-pole Fuse holder for UL Midget with indication light
1002563	F30M3L	3-pole Fuse holder for UL Midget with indication light
1002564	F30M4L	4-pole Fuse holder for UL Midget with indication light
1002565	F30CC1L	1-pole Fuse holder for UL Class CC with indication light
1002566	F30CC2L	2-pole Fuse holder for UL Class CC with indication light
1002567	F30CC3L	3-pole Fuse holder for UL Class CC with indication light
1002568	F30CC4L	4-pole Fuse holder for UL Class CC with indication light
1002569	F30P1L	1-pole Fuse holder for 1000vdc UL PV with indication light
1002570	F30P2L	2-pole Fuse holder for 1000vdc UL PV with indication light
1002598	F30M1	1-pole Fuse holder for UL Midget without indication light
1002599	F30M2	2-pole Fuse holder for UL Midget without indication light
1002600	F30M3	3-pole Fuse holder for UL Midget without indication light
1002601	F30M4	4-pole Fuse holder for UL Midget without indication light
1002602	F30CC1	1-pole Fuse holder for UL Class CC without indication light
1002603	F30CC2	2-pole Fuse holder for UL Class CC without indication light
1002604	F30CC3	3-pole Fuse holder for UL Class CC without indication light
1002605	F30CC4	4-pole Fuse holder for UL Class CC without indication light
1002606	F30P1	1-pole Fuse holder for 1000vdc UL PV without indication light
1002607	F30P2	2-pole Fuse holder for 1000vdc UL PV without indication light

Additional products, accessories and higher ratings available. Contact your NOARK representative or visit na.noark-electric.com for additional information.

F30 Series Fuse Holder

Technical Specifications

Fuse holder	F30M	F30CC	F30P
Conformed Standard	UL4248-1	UL4248-4	UL4248-19
Rated Operational Voltage	600Vac/dc	600Vac/dc	1000Vdc
Rated Current In (A)	Max 30A		
SCCR Rating	200kA	200kA	50kA
Number of Poles	1, 2, 3, 4		1, 2
Maximum Power Loss (W)	3.2W (per pole)		
Type	With & Without Indication Light		
Protection Degree	IP20		
Mounting	35mm DIN-Rail		
Operation Temperature (°C)	-30°C to 85°C		
Altitude ft (m)	Does not exceed 6,561 (2,000)		
Humidity Resistance	At 68°F (+20°C), the relative humidity does not exceed 95%		
	At 104°F (+40°C), the relative humidity does not exceed 50%		
Wet and Heat resistance	Class II		
Pollution Degree	Class III		
Connection	Copper conductor, 18-6 AWG (0.75-10mm ²)		
	Compatible with UL508 Comb busbar		
	Terminal screws, 18 lb-in (2N·m)		
Applicative Fuses	10x38mm Midget fuses (≤30A)	10x38mm Class CC fuses (≤30A)	10x38mm PV fuses (≤30A)
Remarks	75/90°C (167/194°F) Wire CU ONLY		

Additional products, accessories and higher ratings available. Contact your NOARK representative or visit na.noark-electric.com for additional information.

Manual Motor Starters

Ex9S Product Overview

Features

Ex9S Manual Motor Starters provide manual isolation, manual motor control, and overcurrent protection. They are electro-mechanical devices combining the functions below in one unit.

- Disconnect for Motor Branch Circuit
- Manual Motor Control (automatic when used with contactor)
- Branch-Circuit Short Circuit Protection (Magnetic Protection)
- Overload Protection (Thermal Protection) - Trip Class 10

The National Electrical Code requires an individual Motor Branch Circuit to be protected by a UL/CSA Listed Fuse, Circuit breaker or Self-Protected Combination Motor Controller.

Available as:

- Up to 80A @ 600Vac
- UL 60947-4-1 Type E Self Protection - Ex9S32 and Ex9S80
- UL 60947-4-1 Type F Group Motor Protection - Ex9S32
- Built-in fault indication
- Full range of accessories
- Lockable handle



Certifications

- UL listed
- CCC Certified
- NOM Certified
- RoHs Compliant



Standards Compliance

- UL 60947-1; UL 60947-4-1
- IEC/EN 60947-1, IEC/EN 60947-2, IEC/EN 60947-4-1, IEC/EN 60947 -5-1
- GB 14048.1, GB 14048.2, GB 14048.4
- CSA 22.2 No. 60947-1, CSA 22.2 No. 60947-4-1

Manual Motor Starters

Ex9S Product Selection



Ex9S32

Rated Current Amp (Min-Max)	Thermal Magnetic protection	
	Catalog Number	Part Number
0.10~0.16	Ex9S32A0.16A	1600046
0.16~0.25	Ex9S32A0.25A	1600047
0.25~0.40	Ex9S32A0.4A	1600048
0.40~0.63	Ex9S32A0.63A	1600049
0.63~1	Ex9S32A1A	1600050
1~1.6	Ex9S32A1.6A	1600051
1.6~2.5	Ex9S32A2.5A	1600052
2.5~4	Ex9S32A4A	1600053
Rated Current Amp (Min-Max)	Thermal Magnetic protection	
	Catalog Number	Part Number
4~6.3	Ex9S32A6.3A	1600054
6~10	Ex9S32A10A	1600055
9~14	Ex9S32A14A	1600056
13~18	Ex9S32A18A	1600057
17~23	Ex9S32A23A	1600058
20~25	Ex9S32A25A	1600059
24~32	Ex9S32A32A	1600060



Ex9S80

Certifications
IEC/EN 60947-4-1

Rated Current Amp (Min-Max)	Thermal Magnetic protection	
	Catalog Number	Part Number
14~20	Ex9S80A20A	1600170
18~25	Ex9S80A25A	1600171
23~32	Ex9S80A32A	1600172
30~40	Ex9S80A40A	1600173
38~50	Ex9S80A50A	1600174
48~63	Ex9S80A63A	1600175
60~72	Ex9S80A72A	1600176
70~80	Ex9S80A80A	1600177
Rated Current Amp (Min-Max)	Magnetic protection	
	Catalog Number	Part Number
14~20	Ex9S80A20AM	1600185
18~25	Ex9S80A25AM	1600186
23~32	Ex9S80A32AM	1600187
30~40	Ex9S80A40AM	1600188
38~50	Ex9S80A50AM	1600189
48~63	Ex9S80A63AM	1600190
60~72	Ex9S80A72AM	1600191
70~80	Ex9S80A80AM	1600192
Rated Current Amp (Min-Max)	Thermal Magnetic protection	
	Catalog Number	Part Number
14~20	Ex9S80A20B	1600178
18~25	Ex9S80A25B	1600179
23~32	Ex9S80A32B	1600180
30~40	Ex9S80A40B	1600181
38~50	Ex9S80A50B	1600182
48~63	Ex9S80A63B	1600183
60~72	Ex9S80A72B	1600184
Rated Current Amp (Min-Max)	Magnetic protection	
	Catalog Number	Part Number
14~20	Ex9S80A20BM	1600193
18~25	Ex9S80A25BM	1600194
23~32	Ex9S80A32BM	1600195
30~40	Ex9S80A40BM	1600196
38~50	Ex9S80A50BM	1600197
48~63	Ex9S80A63BM	1600198
60~72	Ex9S80A72BM	1600199

Additional products, accessories and higher ratings available. Contact your NOARK representative or visit na.noark-electric.com for additional information.

Manual Motor Starters

Ex9S Technical Data

"Manual Self- Protected Starter"	Overload Trip Range (A)	UL Motor Power (hp) @ 50/60Hz							Short Circuit Rating (SCCR) kA						UL 60947-4-1 Type F Components			
		1 Phase		3 Phase					Stand Alone		UL 508 Type E		UL 508 Type F		UL 60947-4-1 Type E Components	Contactor	DIN rail Base Plate	Manual Motor Starter Connector
		110/120V	220/240V	200V	208V	220/240V	460/480V	575/600V	240V or 480/277V	600/347V	240V or 480/277V	600/347V	240V or 480/277V	600/347V				
Ex9S32A0.16A	0.1-0.16	-	-	-	-	-	-	-	65	5	65	10	65	10	CCE51 and AL5111	Ex9CS09 or Ex9C12	DRA51	CC51 (Mini Contactor) or CC52 (Standard Contactor)
Ex9S32A0.25A	0.16-0.25	-	-	-	-	-	-	-										
Ex9S32A0.4A	0.25-0.4	-	-	-	-	-	-	-										
Ex9S32A0.63A	0.4-.63	-	-	-	-	-	-	-										
Ex9S32A1A	0.63-1	-	-	-	-	-	-	0.5										
Ex9S32A1.6A	1-1.6	-	0.1	-	-	-	0.75	0.75										
Ex9S32A2.5A	1.6-2.5	-	0.167	0.50	0.5	0.5	1	1.5										
Ex9S32A4A	2.5-4	0.125	0.333	0.75	0.75	0.75	2	3										
Ex9S32A6.3A	4-6.3	0.25	0.5	1	1	1.5	3	5										
Ex9S32A10A	6-10	0.5	1.5	2	2	3	5	7.5										
Ex9S32A14A	9-14	0.75	2	3	3	3	10	10	42	42	-	42	-	Ex9C18	Ex9C25	CC52		
Ex9S32A18A	13-18	1	3	5	5	5	10	15*										
Ex9S32A23A	17-23	1.5	3	5	-	7.5	15	20*										
Ex9S32A25A	20-25	2	-	-	-	7.5	15	20*										
Ex9S32A32A	24-32	2	5	7.5	7.5	10	20	25*	42	5	42	-	-	AL5111	-	-		
Ex9S80A20A/B(M)	14- 20A	1	3	5	5	5	10	15										
Ex9S80A25A/B(M)	18- 25A	2	-	-	7.5	7.5	15	20										
Ex9S80A32A/B(M)	23- 32A	2	5	7.5	7.5	10	20	25										
Ex9S80A40A/B(M)	30- 40A	3	-	10	10	-	25	30										
Ex9S80A50A/B(M)	38- 50A	-	-	15	15	15	30	40										
Ex9S80A63A/B(M)	48- 63A	5	10	15	20	20	40	50										
Ex9S80A72A/B(M)	60- 72A	-	-	20	-	25	50	60										
Ex9S80A80A(M)	70- 80A	-	-	25	25	-	60	75	10	10	-	-	-	-	-	-		

* Manual Motor Control and Motor Disconnect only, not applied in Combination Motor Control.

Ex9S32

Manual self-protected starter	Setting Current (A)		Magnetic Trip Rating (A)
	Minimum	Maximum	
Ex9S32A0.16A	0.1	0.16	2.1
Ex9S32A0.25A	0.16	0.25	3.2
Ex9S32A0.4A	0.25	4	4.8
Ex9S32A0.63A	0.4	0.63	7.2
Ex9S32A1A	0.63	1	11
Ex9S32A1.6A	1	1.6	20
Ex9S32A2.5A	1.6	2.5	30
Ex9S32A4A	2.5	4	50
Ex9S32A6.3A	4	6.3	72.5
Ex9S32A10A	6	10	130
Ex9S32A14A	9	14	175
Ex9S32A18A	13	18	230
Ex9S32A23A	17	23	280
Ex9S32A25A	20	25	322
Ex9S32A32A	24	32	416

Ex9S80

Manual self-protected starter	Setting Current (A)		Magnetic Trip Rating (A)	
	Minimum	Maximum	A	B
Ex9S80A20A/B(M)	14	20	310	400
Ex9S80A25A/B(M)	18	25	375	500
Ex9S80A32A/B(M)	23	32	445	680
Ex9S80A40A/B(M)	30	40	560	800
Ex9S80A50A/B(M)	38	50	700	960
Ex9S80A63A/B(M)	48	63	950	1150
Ex9S80A72A/B(M)	60	72	1000	1150
Ex9S80A80A(M)	70	80	1150	-

Manual Motor Starters

Ex9S and Accessories: Technical Data

Description		Ex9S32	Ex9S80
Rated operational current I _e (A)		32A	80A
Conventional rated thermal current I _{th} (A)		0.16~32A	14-80A
Tripping Class		10	
Rated insulation voltage U _i (Vac)		690/IEC; 600/UL, CSA	
Rated operational voltage U _e (AC)		230/240, 400/415, 460/480, 575/600	
Rated impulse withstand voltage U _{imp} (AC)		6,000V	
Rated Operational Frequency (Hz)		50/60Hz	
Resistance to shock		30gn - 11ms	
Resistance to vibrations		5gn (5 - 150Hz)	
Environmental Temperature	Transportation or Storage	-40°F to 176°F (-40°C to 80°C) ¹	
	Working at	-4°F to 140°F (-20°C to 60°C) ²	
	Testing at	59°F to 77°F (15°C to 25°C)	
	Instantaneous limit	-31°F to 158°F (-35°C to 70°C)	
Altitude ft (m)		Not to exceed 6,562 (2,000)	
Ambient Conditions		At mounting site, relative humidity not exceed 90% at the temperature 104°F (40°C), higher relative humidity is allowable under lower temperature	
Pollution Grade		III	
Mounting Conditions		The inclination between the mounting plane and the vertical plane shall not exceed 30°; The product shall be installed and operated at a place without obvious shock, impact and vibration.	
Service life* (cycles)	Electrical	50,000	50,000 (up to 63A); 30,000 (72A & 80A)
	Mechanical	100,000	50,000 (up to 72A); 30,000 (80A)
Duty Class (cycles/hr)		30, max. operating rate	
Degree of Protection		IP20	

1: 24 hours max. at the ultimated temperature

2: with temperature reduction factor

*: close/open operation, and 30 cycles/hr for AC-3 Duty @ 400/415Vac

	Auxiliary contacts AX51	Auxiliary contacts AX52	Auxiliary contacts AX53	Auxiliary contacts AX51
Rated operational voltage U _e	300V	600V	60Vac, 24Vdc	600V
Rated frequency	50/60Hz	50/60Hz	-	50/60Hz
Rated impulse withstand voltage U _{imp}	2500V	6000V	800V	6000V
Conventional rated thermal current (I _{th})"	2.5A	5A	1A	5A
Mechanical life (C-O operations)	100000	100000	100000	100000
Electrical Rating	C300, Q300	B600, Q300	AC-12: 60V/0.1A DC-12: 24V/1A	B600, Q300
Minimum connection Load	5mA @ 24Vac/dc	8mA @ 24Vac/dc	2mA @ 12 Vac/dc or 3mA @ 5Vdc	8mA @ 24Vac/dc

Terminal Wiring

Model	Wire Ranges (AWG)	Torques lb·in (N.m)	Screw Type	Pull wire length inch (mm)	
Phil-Hex head	Ex9S80	14~3	53 (6)	M8	0.59 (15)
Phil-Slot Head	Ex9S32	(1)x14-(2)x8	22 (2.5)	M4	0.4 (10)
	AX51	(1)x18-(2)x12	7 (0.8)	M3	-
	AX52	(1)x18-(2)x12	7 (0.8)	M3	-
	AX53	(1)x18-(2)x14	7 (0.8)	M3	-
	AL51	(1)x18-(2)x12	7 (0.8)	M3	-
	UVT51	(1)x18-(2)x12	15 (1.7)	M3.5	-
	SHT51	(1)x18-(2)x12	15 (1.7)	M3.5	-

Manual Motor Starters

UL 60947-4-1 (formerly UL 508) Type E Application

The National Electrical Code (NEC) requires the following when controlling a motor:

- A means of disconnecting power from the circuit
- Short circuit protection for the cables
- A way to start and stop the motor (typically a contactor)
- Overload protection for the motor (typically an overload relay)

The EX9S32 can provide (self protected) UL 60947-4-1 (formerly UL 508) Type E protection when used in conjunction with a terminal extension and an alarm contact. The Ex9S80 also provide Type E protection when used with an Alarm contact (does not require the use of terminal extension).

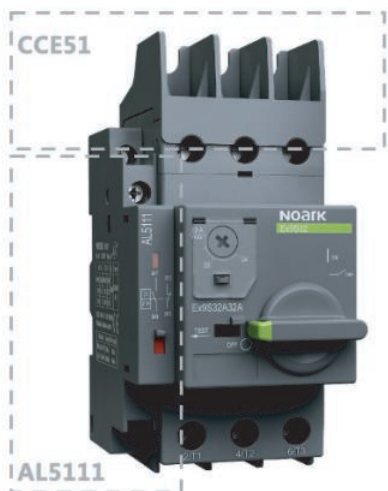



Type E:

9S32 + CCE51 + AL5111

OR

9S80 + AL5111

TYPE E		
Components	Catalog Number	Product
Manual Motor Starter: 0.10-32 Amps 14-80 Amps	EX9S32 Ex9S80	
Fault Signaling/Alarm Contact	AL5111	
Terminal cover/extension: Ex9S32 only	CCE51	

Disclaimer: Proper Sizing of an overcurrent protection device is the responsibility of the customer and should be determined using the application standards of the NEC*, CEC**, or other applicable standards.

*NEC-National Electrical Code

** CEC-Canadian Electrical Code

Manual Motor Starters

UL 60947-4-1 (formerly UL 508) Type F Application

The EX9S32* can provide (group motor) UL 60947-4-1 (formerly UL 508) Type F protection when used in conjunction with a contactor, terminal extension and an alarm contact.

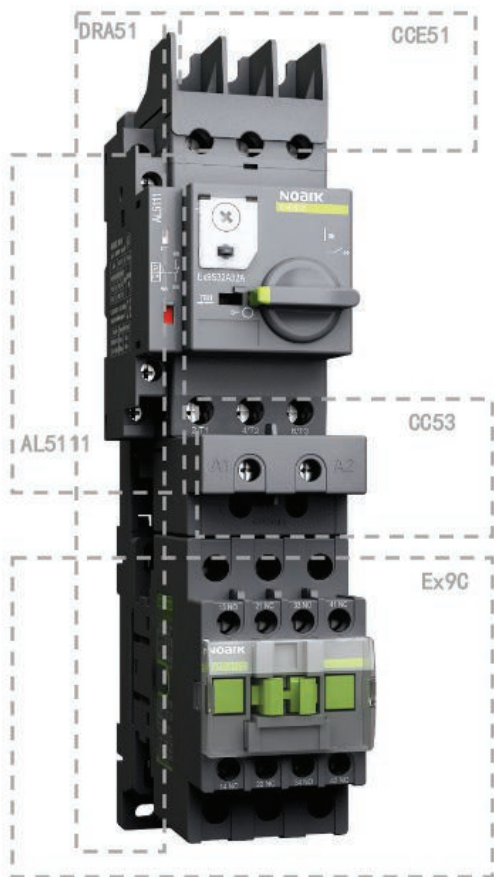

Type F:

9S + CCE51 + AL5111 + 9C + CC53 + DRA51

TYPE F		
Components	Catalog Number	Product
Manual Motor Starter 0.10-32A	EX9S32*	
Terminal cover/extension for Ex9S32	CCE51	
Contactor	EX9C or EX9CS	
Fault Signaling/Alarm Contact	AL5111	
Mounting Bracket for mounting a Ex9S32 to a Ex9C Standard Type Contactor, 9-38A	DRA51	
Connection Block between Ex9S32 and Ex9CS Mini Type Contactor 9-12A	CC51	
	or	
Connection Block between Ex9S32 and Ex9C Standard Type Contactor 9-18A	CC52	
	or	
Connection Block between Ex9S32 and Ex9C Standard Type Contactor 25-38A	CC53	

*Type F protection is not available in Ex9S80

Disclaimer: Proper Sizing of an overcurrent protection device is the responsibility of the customer and should be determined using the application standards of the NEC*, CEC**, or other applicable standards.

*NEC-National Electrical Code
** CEC-Canadian Electrical Code

Manual Motor Starters

Ex9S Accessories

Auxiliary Contact Blocks

Applies to Ex9S32 and Ex9S80

Description	Mounting Location	Max. No. of Blocks	Contact Type	Catalog Number
Instantaneous auxiliary contacts	Front	1	NO+NC	AX5111
			NO+NO	AX5120
			NO+NC	AX5311
	Left Side	2	NO+NC	AX5211
			NO+NO	AX5220
Fault Signaling Contact		1	NC+NC	AX5202
			NO+NC	AL5111



Electrical Trip Unit

Applies to Ex9S32 and Ex9S80

Description	Mounting Location	Voltage	Hz	Catalog Number
Undervoltage Release	Right Side	110-120V	60	UVT51A
		127V	60	UVT51B
		110-120V	50	UVT51B
		208V	60	UVT51C
		240V	60	UVT51D
		480V	60	UVT51E
		600V	60	UVT51F
		220-240V	50	UVT51G
Shunt Release	Right Side	380-415V	50	UVT51H
		100-130V	50/60	SHT51A
		190-330V	50/60	SHT51B
		330-440V	50/60	SHT51C
		480-500V	50/60	SHT51D
		575-600V	50/60	SHT51E



Busbars

Applies to Ex9S32

Description	No. of Ex9S32 Starter	No. of Side-Mounted Aux Contact on each Ex9S32 starter	Busbar Pitch (mm)	Catalog Number
Sets of 3-pole, 63A Busbar	2	None	45	BBUM 245
		1 of AX52, AL51	54	BBUM 254
	4	None	45	BBUM 445
		1 of AX52, AL51	54	BBUM 454
	5	None	45	BBUM 545
		1 of AX52, AL51	54	BBUM 554

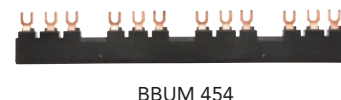

Manual Motor Starters

Ex9S Accessories

Wiring Accessories

Applies to Ex9S32

Description	Application	Catalog Number
Input Terminal for BBUM Busbar	Terminal block for power supply to one or more BBUM bus bar	FD51
Protective end cover	For unused busbar outlets	PC51
Terminal Cover	Terminal cover for Ex9S32 for use in type E application	CCE51



CCE51

Enclosures

Applies to Ex9S32

Description	Type	Color	Rating	Catalog Number
Waterproof Enclosure; Ex9S32 Protectors	Operation by rotary handle	Black/ Gray	NEMA 4X/4, IP 65	WPB51B
		Yellow/ Red		WPB51Y



WPB51B



WPB51Y

Operation Handle

Applies to Ex9S32 and Ex9S80

Description	Type	Color	Rating	Catalog Number
Extended Rotary Handle	9 inch (230mm) shaft, with bracket	Black/ Gray	NEMA 4X/4, IP65	ERH51B
		Yellow/ Red		ERH51Y



ERH51B

Mounting Accessories

Applies to Ex9S32

Description	Application	Catalog Number
Combination Block	Between Ex9S32 and Ex9C Mini Type Contactor, 09-12A	CC51
	Between Ex9S32 and Ex9C Standard Type Contactor, 09-18A	CC52
	Between Ex9S32 and Ex9C Standard Type Contactor, 25-38A	CC53
Mounting Bracket	For mounting a Ex9S32 to a Ex9C Standard Type Contactor, 09-38A	DRA51

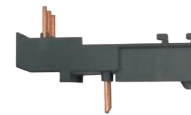

CC51



CC52



CC53

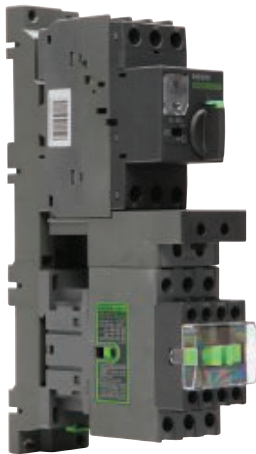

Ex9S32 + CC53 +
Ex9C32 + DRA51



DRA51

IEC Contactors

Ex9C Product Overview

Features

Ex9C series contactors are suitable for a broad range of motor control applications. With many available accessories and options, these contactors have ampacity ratings from 6A to 1000A at 600Vac and can be applied in systems up to 600Vac. A range of overload relays are available in a variety of frame sizes to fit respective contactors of given rated current.

- Nine frame sizes with rated current up to 1000A at 690V AC-3
- Coil control voltage from 24-600Vac and 24-500Vdc
- Wide range electronic coil available for 9-500A contactors
- features built-in surge suppression
- DIN rail 35mm and panel mountable



Certifications

- UL 508 Listed, File No. E353866, UL 60947-1 and 60947-4-1
- CSA C22.2 No. 14, File no. E353866
- IEC/EN 60947-4-1
- CE Approved
- CCC Certified



IEC Contactors

Ex9CS/CSR 6 -12 Amperes Miniature

- Built-in auxiliary contacts on 3-pole; additional auxiliary contacts are front mounted
- Non-Reversing



Certifications
 IEC/EN 60947-1, 60947-4-1
 UL 60947-1, 60947-4-1

Rated Amperage (A)	120Vac Coil		24Vdc Coil	
	Catalog Number	Catalog Number	Catalog Number	Catalog Number
	Power Poles - 3NO Auxiliary Contact - 1NO	Power Poles - 3NO Auxiliary Contact - 1NC	Power Poles - 3NO Auxiliary Contact - 1NO	Power Poles - 3NO Auxiliary Contact - 1NC
3-pole	6	Ex9CS0610G7	Ex9CS06D10B	Ex9CS06D01B
	9	Ex9CS0910G7	Ex9CS09D10B	Ex9CS09D01B
	12	Ex9CS1210G7	Ex9CS12D10B	Ex9CS12D01B
	Power Poles - 4NO	Power Poles - 2NO+2NC	Power Poles - 4NO	Power Poles - 2NO+2NC
4-pole	6	Ex9CS06G7C	Ex9CS06DBC	Ex9CS06DBB
	9	Ex9CS09G7C	Ex9CS09DBC	Ex9CS09DBB
	12	Ex9CS12G7C	Ex9CS12DBC	Ex9CS12DBB

- Built-in auxiliary contacts on 3-pole; additional auxiliary contacts are front mounted
- Reversing





Rated Amperage (A)	120Vac Coil		24Vdc Coil	
	Catalog Number	Catalog Number	Catalog Number	Catalog Number
	Power Poles - 3NO Auxiliary Contact - 1NO	Power Poles - 3NO Auxiliary Contact - 1NC	Power Poles - 3NO Auxiliary Contact - 1NO	Power Poles - 3NO Auxiliary Contact - 1NC
3-pole	6	Ex9CSR0610G7	Ex9CSR06D10B	Ex9CSR06D01B
	9	Ex9CSR0910G7	Ex9CSR09D10B	Ex9CSR09D01B
	12	Ex9CSR1210G7	Ex9CSR12D10B	Ex9CSR12D01B
	Power Poles - 4NO	Power Poles - 2NO+2NC	Power Poles - 4NO	Power Poles - 2NO+2NC
4-pole	6	Ex9CSR06G7C	Ex9CSR06DBC	-
	9	Ex9CSR09G7C	Ex9CSR09DBC	-
	12	Ex9CSR12G7C	Ex9CSR12DBC	-

Additional products, accessories and higher ratings available. Contact your NOARK representative or visit na.noark-electric.com for additional information.

IEC Contactors

Ex9CS/CSR Technical Data

			Ex9CS/CSR		
			6	9	12
General Information					
Pole			3, 4		
Production Standard			IEC 60947-1, IEC 60947-4-1, UL 60947-1, UL 60947-4-1		
Environmental Testing According to			IEC 60068-2-1, IEC 60068-2-2, IEC 60068-2-11, IEC 60068-2-30		
Rated Frequency (Hz)			50/60		
Conventional Free Air Thermal	0 ≤ 104°F (0 ≤ 40°C)		20		
	0 ≤ 140°F (0 ≤ 60°C)				
Current Ith (A)		0 ≤ 158°F (0 ≤ 70°C)	16		
Rated Insulating Voltage Ui (V)			690		
Rated Impulse Withstand Voltage Uimp (kV)			6		
Electrical Life	AC-3	380/400V	1,200,000		
	AC-4		50,000	40,000	
Mechanical Life			10,000,000		
Operating Cycles Per Hour (cycles/h)	AC-3		1,200		
	AC-4		300		
Environmental Temperature	Transportation or Storage		-76 to 176°F (-60 to +80°C)		
	Working At		-4 to 140°F (-20 to +60°C)		
	Maximum		-40 to 158°F (-40 to +70°C)		
Altitude ft (m)			<6,562 (2,000)		
Pollution Degree			Class III		
Rated Operational Current Ie (A)					
At -82 to 131 °F (-25 to 40°C)	AC-1	690V	20		
	AC-3	380/400V	6	9	12
	AC-3	660/690V	3.8	4.9	
	AC-4	380/400V	6	9	12
	AC-4	660/690V	3.8	4.9	
Rated Power of 3-Phase Motor					
For IEC (kW)	AC-3	230Vac	-		
	AC-4		-		
	AC-3	380/400Vac	2.2	4	5.5
	AC-4		-		
	AC-3	660/690Vac	3	4	
	AC-4		-		
	AC-3	1,000Vac	-		
AC-4	-				
UL Rating					
Ith (A)			20		
Single-Phase (HP)	110-120Vac		0.5		0.75
	220-240Vac		1	1.5	2
Three-Phase (HP)	200-208Vac		1.5	3	
	220-240Vac		2		
	440-480Vac		3	5	7.5
	550-600Vac		5	7.5	10
Coil Voltage (V)			24-500Vac, 12-250Vdc		

			Ex9CS/CSR		
			6	9	12
Coil Electrical Parameters					
Tolerance of Control Voltage 50/60 Hz	Operation (Uc)	Standard	85% -, 110%		
	Drop-Off (Uc)	Standard	20% - 75% (AC) 10% - 75% (DC)		
Coil Power Consumption					
In Rush (VA)		AC	70		
Sealed (VA)		AC	9		
Pick-Up (W)		DC	4		
Hold (W)		DC	4		
Operating Time (ms)	Operation	Standard	10-20		
	Drop-Off	Standard	4-16		
IEC AC Contactor Working at DC Power Data					
	Rated Working Voltage (V)	Poles connected in Series	Rated Working Current (A)		
Working Type: DC-1, Resistive Load	24	1	15		
		2			
		3			
Time Data: L/R ≤ 1ms	48/75	1	4		
		2			
		3			
Environmental Temperature: ≤ 140°F (≤ 60°C)	125	1	15		
		2			
		3			
	225	1	1		
		2			
		3			
IEC AC Contactor Working at DC Power Data					
	Rated Working Voltage (V)	Poles connected in Series	Rated Working Current (A)		
Working Type: DC-2 to DC-5, Inductive Load	24	1	15		
		2			
		3			
Time Data: L/R ≤ 15ms	48/75	1	5		
		2			
		3			
Environmental Temperature: ≤ 140 °F (≤ 60 °C)	125	1	1.5		
		2			
		3			
	225	1	11		
		2			
		3			
	225	1	0.5		
		2			
		3			
	225	1	1.5		
		2			
		3			

J

IEC Contactors

Ex9CS/CSR Technical Data

		Ex9CS/CSR		
		6	9	12
Built-In Auxiliary Contacts				
Auxiliary Contacts		1NO or 1NC (3P), None (4P)		
Rated Operation Voltage Ue (V)		690		
Rated Insulating Voltage Ui (V)		690		
Rated Impulse Withstand Voltage Uimp (kV)		6		
Rated Frequency (Hz)		50/60		
Conventional Free Air Thermal Current Ith (A)		10		
Rated Operational Current Ie (A)				
AC-15	120V	6		
	240V	3		
	380V	1.9		
	600V	1.2		
DC-13	125V	0.55		
	220V	0.31		
Mounting	Screw (mm)	ø4		
	DIN rail (mm)	35/7.5		
Dimension LxWxH in		1.93x2.32x2.28		
Weight lb (kg)		0.40 (0.18)		
Degree of Protection		IP20		
Main Power Terminal Connection				
Flexible Cable Without Cold-Press Terminal AWG*	Single Cable	#18-12		
	Dual Cable			
Stiff Cable Without Cold-Press Terminal AWG*	Single Cable	#18-12		
	Dual Cable			
Screw Size ø (mm)		M3		
Torque of Terminals in-lb (N.m)		7 (0.80)		
Auxiliary Contact Terminal Connection				
Flexible Cable Without Cold-Press Terminal AWG*	Single Cable	#18-12		
	Dual Cable			
Stiff Cable With Cold-Press Terminal AWG*	Single Cable	#18-12		
	Dual Cable			
Stiff Cable Without Cold-Press Terminal AWG*	Single Cable	#18-12		
	Dual Cable			
Screw Size ø (mm)		M3		
Torque of Terminals in-lb (N.m)		7 (0.80)		

* AWG = American Wire Gauge

IEC Contactors

Ex9CS/R Accessories

The Ex9CS/C line shares accessories and every contactor can be equipped with one front-mounted unit, two units of side-mounted contact (one from the left, the other from the right) and surge suppressor block.



- For contactors Ex9CS and Ex9CSR
- Field installable
- One unit used with a contactor

Accessory Description	Matched Contactor	Catalog Number
Auxiliary Contact Front Mount Mechanically Linked Contacts (in accordance with IEC 60947-5-1 Annex L) and Mirror Contacts (in accordance with IEC 60947-4-1 Annex F)	Ex9CS06-12 Ex9CSR06-12 (Front Mount)	AX4122UL

Auxiliary Contact Specifications		
UL Standard File Number	E353866	
IEC Standard File Number	IEC/EN 60947-5-1	
Certifications	UL Listed, CSA, CCC	
Electrical Parameters		
Rated Frequency (Hz)	50/60	
Rated Working Voltage U_e	AC-15 (V)	380/400/415
	DC-13 (V)	220/250
Rated Working Current I_e	AC-15 (A)	1.9A
	DC-13 (A)	0.31
Rated Capacity	AC-15 (VA)	720
	DC-13 (W)	69
Rated Thermal Current I_{th} (A)	10	
Rated Impulse Withstand Voltage U_{imp} (kV)	6 (1.2/50ms)	
Rated Insulation Voltage U_i (V)	690	
Mechanical Parameters		
Dimensions (L x W x H) in	1.46 x 1.30 x 1.54	
Degree of Protection	IP20	
Terminals	Lift	
Terminal Capacity AWG*	#18-12	
Torque of Terminals in-lb (N.m)	7 (0.80)	



- Reduces voltage peaks in control circuit
- Versions with varistor and RC circuit technology
- Includes cable lugs for connecting to contactor terminals

Accessory Description	Matched Contactor	Catalog Number
Surge Suppressor Block	Ex9CS06-12	CCU41BUL

Note: external surge protection accessory, CCU42BUL / CCU43BUL is not needed on the F-type contactor with a wide range coil since it is already integral to the coil.

Surge Suppressor Block Specifications	
Electrical Parameters	
Internal Technology	Varistor
Control Coil Voltage U_c (Protection Range)	24-48Vac/dc 110-240Vac/dc 380-415Vac/dc
Maximum Peak Voltage U_p (U_c)	2kV
Mechanical Parameters	
Matched Contactor Type	Ex9CS06-12
Mounting	Mounts to Contactor Control Coil Terminals
Weight lb (kg)	0.04 (0.02)



Accessory Description	Suitable For	Catalog Number
Star Delta Wiring Kit (SDWK)	Ex9CS or Ex9CSR	SDWK41
Reversing wiring kit (REWK)	Ex9CS or Ex9CSR	REWK41

*AWG = America Wire Gauge

J

IEC Contactors

Ex9C 9-1000A Standard

- Built-in auxiliary contacts; 1NO/1NC additional auxiliary contacts are front or side mounted
- Non-Reversing



Certifications
 IEC/EN 60947-1, 60947-4-1
 UL 60947-1, 60947-4-1

Rated Amperage (A)	Wide Range Electronic Coil (with built-in surge suppression)					
	120Vac Coil Catalog Number	24-60Vac/dc Coil Catalog Number	48-130Vac/dc Coil Catalog Number	100-250Vac/dc Coil Catalog Number	250-500Vac/dc Coil Catalog Number	
Power Poles - 3NO Auxiliary Contact - 1NO+1NC						
3-pole	9	Ex9C0911G7	Ex9C09F11J	Ex9C09F11H	Ex9C09F11K	-
	12	Ex9C1211G7	Ex9C12F11J	Ex9C12F11H	Ex9C12F11K	-
	18	Ex9C1811G7	Ex9C18F11J	Ex9C18F11H	Ex9C18F11K	-
	25	Ex9C2511G7	Ex9C25F11J	Ex9C25F11H	Ex9C25F11K	-
	32	Ex9C3211G7	Ex9C32F11J	Ex9C32F11H	Ex9C32F11K	-
	38	Ex9C3811G7	Ex9C38F11J	Ex9C38F11H	Ex9C38F11K	-
	40	Ex9C4011G7	Ex9C40F11J	Ex9C40F11H	Ex9C40F11K	-
	50	Ex9C5011G7	Ex9C50F11J	Ex9C50F11H	Ex9C50F11K	-
	65	Ex9C6511G7	Ex9C65F11J	Ex9C65F11H	Ex9C65F11K	-
	80	Ex9C8011G7	Ex9C80F11J	Ex9C80F11H	Ex9C80F11K	-
	100	Ex9C10011G7	Ex9C100F11J	Ex9C100F11H	Ex9C100F11K	-
Power Poles - 3NO Auxiliary Contact - 2NO+2NC						
115	Ex9C115E22G	-	Ex9C115F22H	Ex9C115F22K	Ex9C115F22L	
150	Ex9C150E22G	-	Ex9C150F22H	Ex9C150F22K	Ex9C150F22L	
185	Ex9C185E22G	-	Ex9C185F22H	Ex9C185F22K	Ex9C185F22L	
225	Ex9C225E22G	-	Ex9C225F22H	Ex9C225F22K	Ex9C225F22L	
265	Ex9C265E22G	-	Ex9C265F22H	Ex9C265F22K	Ex9C265F22L	
300	Ex9C300E22G	-	Ex9C300F22H	Ex9C300F22K	Ex9C300F22L	
400	Ex9C400E22G	-	Ex9C400F22H	Ex9C400F22K	Ex9C400F22L	
500	Ex9C500E22G	-	Ex9C500F22H	Ex9C500F22K	Ex9C500F22L	
630	Ex9C630E22GG	-	-	-	-	
800	Ex9C800E22GG	-	-	-	-	
1,000	Ex9C1000E22GG	-	-	-	-	

Additional products, accessories and higher ratings available. Contact your NOARK representative or visit na.noark-electric.com for additional information.

IEC Reversing Contactors

Ex9C 9-500A Standard Reversing

- Built-in auxiliary contacts; additional auxiliary contacts are front or side mounted
- Reversing
- Reversing contactor is comprised of 2 contactor joined by a mechanical interlock and power connection on 115A and above.



Certifications
 IEC/EN 60947-1, 60947-4-1
 UL 60947-1, 60947-4-1

Rated Amperage (A)	120Vac Coil		Components to build Reversing Contactor*			
	Catalog Number		Quantity	Contactor	Quantity	Mechanical Interlock
	Power Poles - 3NO Auxiliary Contact - 1NO+1NC					
3-pole	9	Ex9CR0911G7	2	Ex9C0911G7	1	MIT42UL
	12	Ex9CR1211G7	2	EX9C1211G7	1	MIT42UL
	18	Ex9CR1811G7	2	EX9C1811G7	1	MIT42UL
	25	Ex9CR2511G7	2	EX9C2511G7	1	MIT42UL
	32	Ex9CR3211G7	2	EX9C3211G7	1	MIT42UL
	38	Ex9CR3811G7	2	EX9C3811G7	1	MIT42UL
	40	Ex9CR4011G7	2	EX9C4011G7	1	MIT43UL
	50	Ex9CR5011G7	2	EX9C5011G7	1	MIT43UL
	65	Ex9CR6511G7	2	EX9C6511G7	1	MIT43UL
	80	Ex9CR8011G7	2	EX9C8011G7	1	MIT43UL
100	Ex9CR10011G7	2	EX9C10011G7	1	MIT43UL	

*Power connection not included for 09-100A

- Built-in auxiliary contacts; additional auxiliary contacts are front or side mounted
- Reversing
- Reversing contactor is comprised of 2 contactor joined by a mechanical interlock and power connection



J

Rated Amperage (A)	120Vac Coil		Components to build Reversing Contactor					
	Catalog Number		Quantity	Contactor	Quantity	Mechanical Interlock	Quantity	Power Connection
	Power Poles - 3NO Auxiliary Contact - 2NO+2NC							
3-pole	115	Ex9CR115E22G	2	Ex9C115E22G	1	MIT44UL	1	PCL185UL
	150	Ex9CR150E22G	2	Ex9C150E22G	1	MIT44UL	1	PCL185UL
	185	Ex9CR185E22G	2	Ex9C185E22G	1	MIT44UL	1	PCL185UL
	225	Ex9CR225E22G	2	Ex9C225E22G	1	MIT45UL	1	PCL300UL
	265	Ex9CR265E22G	2	Ex9C265E22G	1	MIT45UL	1	PCL300UL
	300	Ex9CR300E22G	2	Ex9C300E22G	1	MIT45UL	1	PCL300UL
	400	Ex9CR400E22G	2	Ex9C400E22G	1	MIT46UL	1	PCL500UL
	500	Ex9CR500E22G	2	Ex9C500E22G	1	MIT46UL	1	PCL500UL

Additional products, accessories and higher ratings available. Contact your NOARK representative or visit na.noark-electric.com for additional information.

IEC Reversing Contactors

Ex9C 115-500A Standard Reversing



- Built-in auxiliary contacts; additional auxiliary contacts are front or side mounted
- Reversing
- Reversing contactor is comprised of 2 contactor joined by a mechanical interlock and power connection



Green Highlight = Most Popular

Certifications

IEC/EN 60947-1, 60947-4-1
UL 60947-1, 60947-4-1







Rated Amperage (A)	Wide Range Electronic Coil (built-in surge suppression)			
	48-130Vac/dc Coil	100-250Vac/dc Coil	250-500Vac/dc Coil	
	Catalog Number	Catalog Number	Catalog Number	
Power Poles - 3NO Auxiliary Contact - 2NO+2NC				
3-pole	115	Ex9CR115F22H	Ex9CR115F22K	Ex9CR115F22L
	150	Ex9CR150F22H	Ex9CR150F22K	Ex9CR150F22L
	185	Ex9CR185F22H	Ex9CR185F22K	Ex9CR185F22L
	225	Ex9CR225F22H	Ex9CR225F22K	Ex9CR225F22L
	265	Ex9CR265F22H	Ex9CR265F22K	Ex9CR265F22L
	300	Ex9CR300F22H	Ex9CR300F22K	Ex9CR300F22L
	400	Ex9CR400F22H	Ex9CR400F22K	Ex9CR400F22L
	500	Ex9CR500F22H	Ex9CR500F22K	Ex9CR500F22L

Additional products, accessories and higher ratings available. Contact your NOARK representative or visit na.noark-electric.com for additional information.

IEC Contactors



Ex9C/CR Technical Data

			Ex9C/CR									
			9	12	18	25	32	38	40	50		
Coil Electrical Parameters												
Tolerance of Control Voltage 50/60 Hz	Operation (Uc)	Standard	85% - 110%									
		AC/DC Widerange	85% - 110%									
	Drop-Off (Uc)	Standard	20% - 75% (AC), 10 - 75% (DC)									
		AC/DC Widerange	20% - 75% (AC), 10 - 75% (DC)									
Coil Power Consumption												
AC Only Coil	In Rush (VA)		90		100		240					
	Sealed (VA)		9.5		11.4		36.6					
DC Only Coil	Pick-Up (W)		7		17		36.6					
	Hold (W)		7		17		6					
AC/DC (Widerange)	In Rush (VA)				55		200					
	Sealed (VA)				5.1		6					
	Pick-Up (W)				30		150					
	Hold (W)				2		4.5					
Operating Time (ms)	AC Only and DC Only Coil	Operation	12-24		14-27		20-30					
		Drop-Off	6-20		7-22		8-20					
	AC/DC (Widerange)	Operation	45-65				50-100					
		Drop-Off	20-90				20-120					
IEC AC Contactor Working at DC Power Data												
	Rated Working Voltage (V)	Poles of Series Connection	Rated Working Current (A)									
Working Type: DC-1, Resistive Load	24	1										
		2										
		3										
	48/75	1	20	25	32	40	50	65				
		2										
		3										
Time Data: L/R ≤ 1ms	125	1	4		7							
		2	20	25	32	40	50	65				
		3										
	225	1	1				1.5					
		2	4		7							
		3	20	25	32	40	50	65				
IEC AC Contactor Working at DC Power Data												
	Rated Working Voltage (V)	Poles of Series Connection	Rated Working Current (A)									
Working Type: DC-2 to DC-5, Inductive Load	24	1										
		2	20	25	32		40	50	65			
		3										
	48/75	1	8		32			40	50	65		
		2	20	25								
		3										
Time Data: L/R ≤ 15ms	125	1	2		3			4				
		2	15									
		3	20	25	32	40	50	65				
	225	1	0.5		1			1.5				
		2	2		3			4				
		3	8		32	40	50	65				

J

IEC Contactors

Ex9C/CR Technical Data

			Ex9C/CR										Ex9C			
			65	80	100	115	150	185	225	265	300	400	500	630	800	1000
Coil Electrical Parameters																
Tolerance of Control Voltage 50/60 Hz	Operation (Uc)	85% - 110%														
	Drop-Off (Uc)	20% - 70%					20% - 60%									
Coil Power Consumption																
AC Only Coil	In Rush (VA)	240	280				400	590			600	850				
	Sealed (VA)	36			10											
DC Only Coil	Pick-Up (W)	17			400			590			600	850				
	Hold (W)	10														
AC/DC (Wide-range)	In Rush (VA)	200			400			590			600	-				
	Sealed (VA)	6														
	Pick-Up (W)	150			400			590			600	-				
	Hold (W)	4.5														
Operating Time (ms)	AC Only and DC Only Coil	Operation	20-30	20-35	31-64			45-100			58-95	100-180				
		Drop-Off	8-20	6-20	44-68			47-67			85-120	100-120				
	AC/DC Wide- range	Operation	50-100			31-64			45-100			58-95	-			
		Drop-Off	20-120			44-68			47-67			85-120	-			
IEC AC Contactor Working at DC Power Data																
	Rated Working Voltage (V)	Poles of Series Connection	Rated Working Current (A)													
Working Type: DC-1, Resistive Load	24	1														
		2														
		3														
	48/75	1	65	100	160			200	300	400						
		2														
		3														
Time Data: L/R≤1ms	125	1	7	12	18			33								
		2	65	100	160			200	300	400						
		3														
	225	1	1.5		3.4			3.8								
		2	7	12	20			30			40					
		3	65	100	160			200	300	400						
IEC AC Contactor Working at DC Power Data																
	Rated Working Voltage (V)	Poles of Series Connection	Rated Working Current (A)													
Working Type: DC-2 to DC-5, Inductive Load	24	1														
		2														
		3														
	48/75	1	65	100	160			200	300	400						
		2														
		3														
Time Data: L/R≤15ms	125	1	4	5	7.5			11								
		2	65	100	160			200	300	400						
		3														
	225	1	1.5	2	2.5											
		2	4	5	7.5			11								
		3	65	100	160			200	300	400						

IEC Contactors

Ex9C/CR Technical Data

		Ex9C/CR							
		9	12	18	25	32	38	40	50
Built-In Auxiliary Contacts									
Auxiliary Contacts		1NO+1NC, 2NO+2NC						1NO+1NC	
Rated Operation Voltage U _e (V)		690							
Rated Insulating Voltage U _i (V)		690							
Rated Impulse Withstand Voltage U _{imp} (kV)		6							
Rated Frequency (Hz)		50/60							
Conventional Free Air Thermal Current I _{th} (A)		10							
Rated Operational Current I_e (A)									
AC-15	120V	6							
	240V	3							
	380V	1.9							
	600V	1.2							
	125V	0.55							
	220V	0.31							
Mounting	Screw (mm)	ø4						ø5	
	DIN rail (mm)	35						35 or 75	
	Dimension (L x W x H) in	3.50 x 1.77 x 3.70			3.94 x 1.77 x 4.25			4.80 x 2.99 x 4.84	
Weight lb (kg)		0.77 (0.35)			0.88 (0.40)			2.71 (1.23)	
Degree of Protection		IP 20 (Control Circuit Terminal), IP 00 (Main Circuit Terminal)							
Main Power Terminal Connection									
Flexible Cable Without Cold-Press Terminal AWG*	Single Cable	#18-10			#14-8			#14-4	
	Dual Cable	#18-10			#14-8			#14-4	
Stiff Cable Without Cold-Press Terminal AWG*	Single Cable	#18-10			#14-8			#14-4	
	Dual Cable	#18-10			#14-8			#14-4	
Screw Size ø (mm)		M3.5			M4			M8	
Torque of Terminals in-lb (N.m)		15 (1.70)			22 (2.50)			53 (6)	
Auxiliary Contact Terminal Connection									
Flexible Cable Without Cold-Press Terminal AWG*	Single Cable	#18-12							
	Dual Cable	#18-12							
Stiff Cable With Cold-Press Terminal AWG*	Single Cable	#18-12							
	Dual Cable	#18-12							
Screw Size ø (mm)		M3.5							
Torque of Terminals in-lb (N.m)		15 (1.70)							

* AWG = American Wire Gauge

J

IEC Contactors

Ex9C/CR Technical Data

		Ex9C/CR											
		65	80	100	115	150	185	225	265	300	400	500	
Built-In Auxiliary Contacts													
Auxiliary Contacts		1NO+1NC					2NO+2NC						
Rated Operation Voltage U _e (V)		690											
Rated Insulating Voltage U _i (V)		6											
Rated Impulse Withstand Voltage U _{imp} (kV)		50/60											
Rated Frequency (Hz)		10											
Conventional Free Air Thermal Current I _{th} (A)													
Rated Operational Current I_e (A)													
AC-15	24V	-					6						
	120V	6					-						
	230V	-					3.13						
	240V						3						
	380V	1.9					-						
	400V	-					1.8						
	600V	1.2					-						
	690V	-					1.04						
DC-13	24V	0.55											
	125V	0.55											
	220V	0.31											
	250V	0.27											
Mounting	Screw (mm)	ø5				ø8			ø9				
	DIN rail (mm)	35 or 75							-				
Dimension (L x W x H) in		4.80 x 2.99 x 4.84	5.12 x 3.43 x 5.12		6.81 x 4.72 x 6.85			8.39 x 5.71 x 8.19			8.50 x 6.30 x 9.02		
Weight lb (kg)		2.71 (1.23)		3.31 (1.50)		6.61 (3)			13.23 (6)			20.94 (9.5)	
Degree of Protection		IP 20											
Main Power Terminal Connection													
Flexible Cable Without Cold-Press Terminal AWG*	Single Cable	#14-4	#12 - 1/0		(1x) #4 - (2x) 250 MCM			(1x) 1/0 - (2x) 500 MCM					
	Dual Cable		#12 - 1										
Stiff Cable Without Cold-Press Terminal AWG*	Single Cable		#12 - 1/0										
	Dual Cable		#12 - 1										
Screw Size ø (mm)		M8					M10						
Torque of Terminals in-lb (N.m)		53 (6)		79 (9)		159 (18)			310 (35)				
Bus Bar Terminal Connection													
Bus Bar Size		-				2x0.75x0.25 (2x20x5)			2x1x0.25 (2x30x5)		2x1.25x0.25 (2x40x5)		
Screw Size ø (mm)						M8			M10				
Torque of Terminals in-lb (N.m)						159 (18)			310 (35)				
Auxiliary Contact Terminal Connection													
Flexible Cable Without Cold-Press Terminal AWG*	Single Cable	#18-12											
	Dual Cable												
Stiff Cable With Cold-Press Terminal AWG*	Single Cable												
	Dual Cable												
Stiff Cable Without Cold-Press Terminal AWG*	Single Cable												
	Dual Cable												
Screw Size ø (mm)		M3.5											
Torque of Terminals in-lb (N.m)		15 (1.70)											

* AWG = American Wire Gauge

IEC Contactors

Ex9C Technical Data

		Ex9C		
		630	800	1000
Built-In Auxiliary Contacts				
Auxiliary Contacts		2NO+2NC		
Rated Operation Voltage Ue (V)		690		
Rated Insulating Voltage Ui (V)		690		
Rated Impulse Withstand Voltage Uimp (kV)		6		
Rated Frequency (Hz)		50/60		
Conventional Free Air Thermal Current Ith (A)		10		
Rated Operational Current Ie (A)				
AC-15	24V	6		
	230V	3.13		
	240V	3		
	400V	1.8		
	690V	1.04		
DC-13	24V	0.55		
	125V	0.55		
	220V	0.31		
	250V	0.27		
Mounting	Screw (mm)	11.5		
	DIN rail (mm)	-		
Dimension (LxWxH) in		11.73x9.06x10.47	12.68x9.06x10.47	
Weight lb		44.53	48.5	49.16
Degree of Protection		IP20 (Control Circuit Terminal) IP00 (Main Circuit Terminal)		
Main Power Terminal Connection				
Flexible Cable Without Cold-Press Terminal AWG*	Single Cable	LTC25NB 250-600 LTC25NC 4/0-500	LTC26NC 3/0-750 LTC26ND 3/0-500	
	Dual Cable			
Stiff Cable Without Cold-Press Terminal AWG*	Single Cable			
	Dual Cable			
Screw Size ø (mm)		M12	4*M10	
Torque of Terminals in-lb (N.m)		310(45)	310(35)	
Auxiliary Contact Terminal Connection				
Flexible Cable Without Cold-Press Terminal AWG*	Single Cable	#18-12		
	Dual Cable			
Stiff Cable With Cold-Press Terminal AWG*	Single Cable			
	Dual Cable			
Stiff Cable Without Cold-Press Terminal AWG*	Single Cable			
	Dual Cable			
Screw Size ø (mm)		M3.5		
Torque of Terminals in-lb (N.m)		15 (1.70)		

* AWG = American Wire Gauge

J

IEC Contactors

Ex9C Accessories

The Ex9CS/C line shares accessories and every contactor can be equipped with one front-mounted unit, two side-mounted contacts (one left, one right) and surge suppressor block.

Front Mount Auxiliary Contact



- Field installable
- One unit used with a contactor

Side Mount Auxiliary Contact



- Field installable
- One unit used with a contactor on the left side, another unit on the right side

Accessory Description	Matched Contactor	Auxiliary Contact	Catalog Number
Auxiliary Contact	Ex9C09-500 Ex9CR09-500 (Front Mount)	1NO+1NC	AX4211UL
		2NO+2NC	AX4222UL
		3NO+1NC	AX4231UL
Mechanically Linked Contacts (in accordance with IEC 60947-5-1 Annex L) and Mirror Contacts (in accordance with IEC 60947-4-1 Annex F)	Ex9C09-100 Ex9CR09-100 (Side Mount)	1NO+1NC	AX4311UL

Auxiliary Contact		Front Mount AX42	Side Mount AX43
UL Standard File Number		E353866	
IEC Standard File Number		IEC/EN 60947-5-1	
Certifications		UL Listed, CSA, CCC	
Electrical Parameters			
Rated Frequency (Hz)		50/60	
Rated Working Voltage Ue	AC-15 (V)	380/400/415	
	DC-13 (V)	220/250	
Rated Working Current Ie	AC-15 (A)	1.9A	
	DC-13 (A)	0.31	
Rated Capacity	AC-15 (VA)	720	
	DC-13 (W)	69	
Rated Thermal Current Ith (A)		10	
Rated Impulse Withstand Voltage Uimp (kV)		6 (1.2/50ms)	
Rated Insulation Voltage Ui (V)		690	
Mechanical Parameters			
Device Width in		1.89	0.43
Device Height in		1.46	
Device Depth in		1.02 (1NO+1NC)	1.77 (2NO+2NC, 3NO+1NC) 2.76 (1NO+1NC)
Degree of Protection		IP20	
Terminals		Lift	
Terminal Capacity AWG*		#18-12	
Torque of Terminals in-lb (N.m)		15 (1.70)	

* AWG = American Wire Gauge

Additional products, accessories and higher ratings available. Contact your NOARK representative or visit na.noark-electric.com for additional information.

IEC Contactors

Ex9C Accessories

Mechanical Interlock



Power Connection

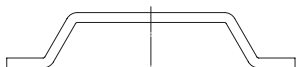

Surge Suppressor Block

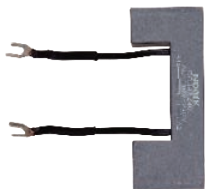

- Reduces voltage peaks in control circuit
- Versions with varistor and RC circuit technology
- Includes cable lugs for connecting to contactor terminals

Accessory Description	Matched Contactor	Catalog Number
Mechanical Interlock (for Ex9C)	Ex9C09-38	MIT42UL
	Ex9C40-100	MIT43UL
	Ex9C115-185	MIT44UL
	Ex9C225-300	MIT45UL
	Ex9C400-500	MIT46UL
Power Connection (for Ex9C)	Ex9C115-185	PCL185UL
	Ex9C225-300	PCL300UL
	Ex9C400-500	PCL500UL
Surge Suppressor Block	Ex9C09-38	CCU42BUL
	Ex9C40-100	CCU43BUL

Note: external surge protection accessory, CCU42BUL / CCU43BUL is not needed with wide range coil since it is already integral to the coil.

Specifications	CCU42	CCU43
Electrical Parameters		
Internal Technology	Resistance	
Control Coil Voltage U_c (Protection Range)	110-240Vac/dc	
Maximum Peak Voltage U_p (U_c)	3kV	
Mechanical Parameters		
Matched Contactor Type	Ex9C09-38	Ex9C40-100
Mounting	Mounts to Contactor Control Coil Terminals	
Weight lb (kg)	0.04 (0.02)	

J

Additional products, accessories and higher ratings available. Contact your NOARK representative or visit na.noark-electric.com for additional information.

IEC Contactors

Ex9C Accessory Specifications

Green Highlight = Most Popular



Accessory Description	Matched Contactor	Relay Type	Timing Range	Catalog Number
Time Delay Relay (Pneumatic Timer)	Ex9C09-500	Off Delay	0.1 - 3 s	AXCD0UL
			0.1 - 30 s	AXCD2UL
			10 - 180 s	AXCD4UL
		On Delay	0.1 - 3 s	AXCT0UL
			0.1 - 30 s	AXCT2UL
			10 - 180 s	AXCT4UL



Accessory Description	Type	Catalog Number
Terminal Cover	Ex9C115~185	TCV46
	Ex9C225~500	TCV47



Accessory Description	Suitable For	Catalog Number
Star Delta Wiring Kit	Ex9C 115-185	SDWK45



Accessory Description	Use with Relay	Catalog Number
Surface mount	Ex9R38	AD56UL
	Ex9R100	AD53UL
	Ex9R185	AD54UL
	Ex9R500	AD55UL

Mounting Base	AD56UL	AD53UL	AD54UL	AD55UL
Current Rating (A)	38	104	185	500
Voltage (Vac)	600			
Terminal Wire Range AWG*	#18 - #8	#12 - #1		
Terminal Torque in-lb (N.m)	22 (2.50)	80 (9)		
Wire Strip Length in	0.51	0.71		
Matched Contactor Type	Ex9C09-38	Ex9C40-100	Ex9C115-185	Ex9C225-500

* AWG = American Wire Gauge

Additional products, accessories and higher ratings available. Contact your NOARK representative or visit na.noark-electric.com for additional information.

Thermal Overload Relays

Ex9R Product Overview

Features

- For use with Ex9C and Ex9CR*
- Rated current up to 500A @ 600 Vac, 50/60 Hz
- Adjustable current setting for overload protection
- Overload protection trip Class 10 and Class 10A
- Phase loss protection
- Automatic or manual reset selectable
- Status indication
- STOP and TEST function
- Direct mount to contactors or 35 mm DIN rail mounting base option
- 5-Year limited warranty



*see page 95 for overloads for use with miniature contactors.



Certifications

- UL 508 Listed, File Number No. E353865, UL 60947-1 and 60947-4-1
- CSA C22.2 No. 14, File no. E353865
- IEC/EN 60947-4-1
- CE Approved
- CCC Certified



Thermal Overload Relays

Ex9R 38-500 Amperes



Certifications
IEC/EN 60947-4-1

CE cUL LISTED

CCC

Rated Amperage (Min - Max)	38A	
	Use with Contactors: Ex9C9-38	
	Catalog Number	
0.63-1	Ex9R38B1A	
1-1.6	Ex9R38B1.6A	
1.6-2.5	Ex9R38B2.5A	
2.5-4	Ex9R38B4A	
4-6	Ex9R38B6A	
5.5-8	Ex9R38B8A	
7-10	Ex9R38B10A	
9-13	Ex9R38B13A	
12-18	Ex9R38B18A	
16-24	Ex9R38B24A	
23-32	Ex9R38B32A	
30-38	Ex9R38B38A	

Rated Amperage (Min - Max)	100A	
	Use with Contactors: Ex9C40-100	
	Catalog Number	
23-32	Ex9R100B32A	
30-40	Ex9R100B40A	
37-50	Ex9R100B50A	
48-65	Ex9R100B65A	
55-70	Ex9R100B70A	
63-80	Ex9R100B80A	
80-104	Ex9R100B104A	



Rated Amperage (Min - Max)	185A	
	Use with Contactors: Ex9C115-185	
	Catalog Number	
75-115	Ex9R185B115A	
110-150	Ex9R185B150A	
140-210	Ex9R185B210A	

Rated Amperage (Min - Max)	500A	
	Use with Contactors: Ex9C225-500	
	Catalog Number	
160-225	Ex9R500B225A	
210-300	Ex9R500B300A	
280-400	Ex9R500B400A	
380-500	Ex9R500B500A	

Additional products, accessories and higher ratings available. Contact your NOARK representative or visit na.noark-electric.com for additional information.

Thermal Overload Relays

Ex9R Technical Data

		Ex9R	
Tripping Class		Class 10/10A	
Operating Frequency (Hz)		50/60	
Phase Failure Protection Function		Yes	
Automatic and Manual Reset			
Temperature Compensation			
Tripping Indicator			
Test and Stop Pushbutton			
Environmental Conditions	Altitude ft (m)	<6,562 (2,000)	
	Pollution Degree	Class III	
Rated Tripping Current (In)		1.2	
Sensitivity to Phase Failure (In)		30%	
Rated Working Voltage (V)		600	
Rated Impulse Withstand Voltage Uimp		6 kV	
Auxiliary Contacts	Number of Contacts		1NO+1NC
	Rated Operating Voltage Ue (V)	AC-15	220/380
		DC-13	220
	Rated Operating Current Ie (A)	AC-15	1.64 / 0.95
		DC-13	0.13
	Circuit Continuous Current		5 A 600 Vac, 1 A 300 Vdc
	Contact Rating		B600, R300
	Terminal Wire Range AWG*		#18-12
Terminal Torque in-lb (N.m)		15 (1.70)	
Terminal Wire Strip Length in		0.43	

* AWG = American Wire Gauge

Thermal Overload Relays

Ex9R Technical Data

Frame Size	38A											
Current Setting Range (A)	0.63-1	1-1.6	1.6-2.5	2.5-4	4-6	5.5-8	7-10	9-13	12-18	16-24	23-32	30-38
Short Circuit Rating, 3 Phase at 600 Vac (kA)	1					5						
Power Terminal	#18-8 AWG*											
Power Terminal Torque in-lb (N.m)	22 (2.5)											
Matched Contactor Type	Ex9C9-38											
Surface mount adapter for remote mounting	AD56UL											

Frame Size	100A							
Current Setting Range (A)	23-32	30-40	37-50	48-65	55-70	63-80	80-104	
Short Circuit Rating, 3 Phase at 600 Vac (kA)	5				10			
Power Terminal	#12-1 AWG*							
Power Terminal Torque in-lb (N.m)	80 (9)							
Matched Contactor Type	Ex9C40-100							
Surface mount adapter for remote mounting	AD53UL							

Frame Size	185A		
Current Setting Range (A)	75-115	110-150	140-210
Short Circuit Rating, 3 Phase at 600 Vac (kA)	10		
Power Terminal	Bus Bar Only		
Power Terminal Torque in-lb (N.m)	159 (18)		
Matched Contactor Type	Ex9C115-185		
Surface mount adapter for remote mounting	AD54UL		

Frame Size	500A			
Current Setting Range (A)	160-225	210-300	280-400	380-500
Short Circuit Rating, 3 Phase at 600 Vac (kA)	30			
Power Terminal	Bus Bar Only			
Power Terminal Torque in-lb (N.m)	310 (35)			
Matched Contactor Type	Ex9C225-500			
Surface mount adapter for remote mounting	AD55UL			

* AWG = American Wire Gauge

Thermal Overload Relay

Ex9R - Thermal Overload Relay (For Ex9CS Miniature Contactors)



12 A	
Rated Amperage (Min - Max)	Use with Contactors: Ex9CS06-12 Catalog Number
0.1-0.16	Ex9R12B0.16A
0.16-0.25	Ex9R12B0.25A
0.25-0.4	Ex9R12B0.4A
0.4-0.63	Ex9R12B0.63A
0.63-1	Ex9R12B1A
1-1.6	Ex9R12B1.6A
1.6-2.5	Ex9R12B2.5A
2.5-4	Ex9R12B4A
4-6	Ex9R12B6A
5.5-8	Ex9R12B8A
7-10	Ex9R12B10A
9-12	Ex9R12B12A

		Ex9R	
Tripping Class		Class 10/10A	
Operating Frequency (Hz)		50/60	
Phase Failure Protection Function			
Automatic and Manual Reset			
Temperature Compensation		Yes	
Tripping Indicator			
Test and Stop Pushbutton			
Environmental Conditions	Altitude ft (m)	<6,562 (2,000)	
	Pollution Degree	Class III	
Rated Tripping Current (In)		1.2	
Sensitivity to Phase Failure (In)		30%	
Rated Working Voltage (V)		600	
Rated Impulse Withstand Voltage Uimp		6 kV	
Auxiliary Contacts	Number of Contacts		1NO+1NC
	Rated Operating Voltage Ue (V)	AC-15	220/380
		DC-13	220
	Rated Operating Current Ie (A)	AC-15	1.64 / 0.95
		DC-13	0.13
	Circuit Continuous Current		(5 A) 600 Vac, (1 A) 300 Vdc
	Contact Rating		B600, R300
	Terminal Wire Range AWG*		#18-12
	Terminal Torque in-lb (N.m)		15 (1.70)
Terminal Wire Strip Length in		0.43	

Ex9R	12 A											
Current Rated (A)	0.16-1.6						2.5-12					
Current Setting Range (A)	0.1-0.16	0.16-0.25	0.25-0.4	0.4-0.63	0.63-1	1-1.6	1.6-2.5	2.5-4	4-6	5.5-8	7-10	9-12
Short Circuit Rating, 3 Phase at 600 Vac (kA)	1						5					
Power Terminal	#18-10 AWG*											
Power Terminal Torque in-lb (N.m)	15 (1.7)											
Matched Contactor Type	Ex9CS06-12											
Matched Adapter	AD51UL											

* AWG = American Wire Gauge



AD51UL

Accessory Description	Catalog Number
Surface mount for Ex9R 0.16-12A only	AD51UL

Mounting Base	AD51UL
Current Rating (A)	12
Voltage (Vac)	600
Terminal Wire Range	#18-12 AWG*
Terminal Torque in-lb (N.m)	7 (0.80)
Matched Contactor Type	Ex9CS06-12

- Allows surface mounting of overload relays listed above (Ex9R 0.16-12A) remotely from miniature contactor (Ex9CS).

Disclaimer: Proper Sizing of an overcurrent protection device is the responsibility of the customer and should be determined using the application standards of the NEC*, CEC**, or other applicable standards.

*NEC-National Electrical Code

** CEC-Canadian Electrical Code

Additional products, accessories and higher ratings available. Contact your NOARK representative or visit na.noark-electric.com for additional information.

Electronic Thermal Overload Relay

Ex9RE - Electronic Thermal Overload Relay



Rated Amperage (min-Max)	Power Supply Voltage	Auxiliary Contacts	Trip Curve Class	Catalog Number
Use with Ex9C 09-38A Contactor				
0.1 - 0.5A	24 Vac/Vdc	1NO+1NC	5/10/20/30	Ex9RE40A0.5
	110/120 Vac			Ex9RE40B0.5
	220/240 Vac			Ex9RE40C0.5
0.4 - 2A	24 Vac/Vdc	1NO+1NC	5/10/20/30	Ex9RE40A02
	110/120 Vac			Ex9RE40A02
	220/240 Vac			Ex9RE40C02
1.8 - 9A	24 Vac/Vdc	1NO+1NC	5/10/20/30	Ex9RE40A09
	110/120 Vac			Ex9RE40B09
	220/240 Vac			Ex9RE40C09
8 - 40A	24 Vac/Vdc	1NO+1NC	5/10/20/30	Ex9RE40A40
	110/120 Vac			Ex9RE40B40
	220/240 Vac			Ex9RE40C40



AD57UL

Accessory Description	Catalog Number
DIN Rail Mount for Ex9RE40 only	AD57UL

- Allows DIN rail mounting of electronic overload relays listed above (Ex9RE40) remotely from contactor (Ex9C).

Additional products, accessories and higher ratings available. Contact your NOARK representative or visit na.noark-electric.com for additional information.

Safety Contactors

Ex9CA Product Overview

Features

The NOARK Ex9CA Safety Contactor is designed for use in safety function applications. It offers special features that allow the design of safe control circuits with current ratings up to 38 Amps.

The Normally Closed (NC) Auxiliary contact is a mirror contact to the main contacts and is mechanically linked to the Normally Open (NO) Auxiliary contacts. This allows for optimal design selections in SRP/CS*.

* SRP/CS is the term given by ISO short for safety-related part of a control system, meaning part of a control system that responds to safety-related input signals and generates safety-related output signals.

- Positively guided mirror contacts/mechanically linked contacts according to IEC/UL 60947-4-1 Annex F, IEC/UL 60947-5-1 Annex L
- Mirror contacts/ mechanically linked symbol on the side of auxiliary block
- Fixed transparent anti-dust cover for easy identification of the device action and prevents the manual operation
- AC or DC operating coils
- Integrated body with built in auxiliary contacts up to 2NC and 2NO
- Integrated surge suppression on DC coil models
- 5-Year limited warranty

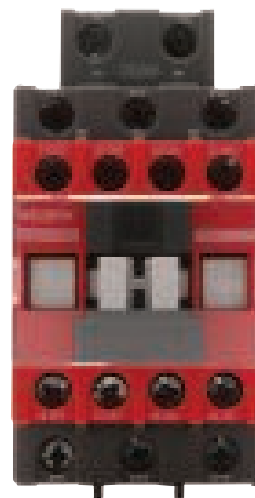

Certifications

- UL Listed, File Number E353865, UL 60947-1
- Certified for Canada CSA standards under cUL testing
- IEC/EN 60947-4-1
- CE Approved
- CCC Certified



Safety Contactors

Ex9CA 9 - 38 A



Rated Amperage (A)		9A		12A	
Coil Voltage		Catalog Number	Catalog Number	Catalog Number	Catalog Number
		Power Poles - 3NO Auxiliary Contact - 1NO+1NC	Power Poles - 3NO Auxiliary Contact - 2NO+2NC	Power Poles - 3NO Auxiliary Contact - 1NO+1NC	Power Poles - 3NO Auxiliary Contact - 2NO+2NC
AC	120	Ex9CA0911G7	Ex9CA0922G7	Ex9CA1211G7	Ex9CA1222G7
DC	24	Ex9CA09D11B	Ex9CA09D22B	Ex9CA12D11B	Ex9CA12D22B

Rated Amperage (A)		18A		25A	
Coil Voltage		Catalog Number	Catalog Number	Catalog Number	Catalog Number
		Power Poles - 3NO Auxiliary Contact - 1NO+1NC	Power Poles - 3NO Auxiliary Contact - 2NO+2NC	Power Poles 3NO Auxiliary Contact - 1NO+1NC	Power Poles 3NO Auxiliary Contact - 2NO+2NC
AC	120	Ex9CA1811G7	Ex9CA1822G7	Ex9CA2511G7	Ex9CA2522G7
DC	24	Ex9CA18D11B	Ex9CA18D22B	Ex9CA25D11B	Ex9CA25D22B

Rated Amperage (A)		32A		38A	
Coil Voltage		Catalog Number	Catalog Number	Catalog Number	Catalog Number
		Power Poles - 3NO Auxiliary Contact - 1NO+1NC	Power Poles - 3NO Auxiliary Contact - 2NO+2NC	Power Poles - 3NO Auxiliary Contact - 1NO+1NC	Power Poles - 3NO Auxiliary Contact - 2NO+2NC
AC	120	Ex9CA3211G7	Ex9CA3222G7	Ex9CA3811G7	Ex9CA3822G7
DC	24	Ex9CA32D11B	Ex9CA32D22B	Ex9CA38D11B	Ex9CA38D22B

Additional products, accessories and higher ratings available. Contact your NOARK representative or visit na.noark-electric.com for additional information.

Safety Contactors

Technical Data

			Ex9CA					
			9	12	18	25	32	38
General Information								
Pole			3					
Production Standard			IEC 60947-1, IEC 60947-4-1, UL 60947-1, UL 60947-4-1, GB/T14048.4					
Environmental Testing According to			IEC 60068-2-1, IEC 60068-2-2, IEC 60068-2-11, IEC 60068-2-30					
Rated Frequency (Hz)			50/60					
Conventional Free Air Thermal Current Ith (A)	0≤104 °F (0≤40 °C)		25	32	40	50		
	0≤140 °F (0≤60 °C)							
	0≤158 °F (0≤70 °C)		17	22	28	35		
Rated Insulating Voltage Ui (V)			690					
Rated Impulse Withstand Voltage Uimp (kV)			6					
Electrical Life	AC-3	380/400 V	1,200,000					
	AC-4		50,000	40,000	50,000	40,000		
Mechanical Life			10,000,000					
Operating Cycles Per Hour (cycles/h)	AC-3	1,200			1,000			
	AC-4	300			150			
Environmental Temperature	Transportation or Storage		-76 to 176 °F (-60 to +80 °C)					
	Working At		-4 to 140 °F (-20 to +60 °C)					
	Maximum		-40 to 158 °F (-40 to +70 °C)					
Altitude ft (m)			<6,562 (2,000)					
Pollution Degree			Class III					
Rated Operating Voltage (Ue)	AC 50/60 HZ		24, 48, 120, 240					
	DC							
Rated Operational Current Ie (A)								
At -82 to 131 °F (-25 to 40 °C)	AC-1	690V	25	32	40	50		
	AC-3	380/400V	9	12	18	25	32	38
	AC-3	660/690V	6.7	9	10.6	17.3	21.9	
	AC-4	380/400V	9	12	18	25	32	
	AC-4	660/690V	6.7	8.9	14	17.3		
Rated Power of 3-Phase Motor								
For IEC (kW)	AC-3	230 Vac	-					
	AC-4							
	AC-3	380/400 Vac	4	5.5	7.5	11	15	18.5
	AC-4						15	
	AC-3	660/690 Vac	5.5	7.5	9	15	18.5	
	AC-4		5.5	7.5	11	15		
AC-3	1,000 Vac	-						
AC-4								
UL Rating								
Ith (A)			25	32	40	50		
Single-Phase (HP)	110-120 Vac		0.5	1	1.5	2	3	
	220-240 Vac		1.5	2	3		5	
Three-Phase (HP)	200-208 Vac		3		5	7.5	10	
	220-240 Vac							
	440-480 Vac		5	7.5	10	15	20	
	550-600 Vac		7.5	10	15	20	25	



Safety Contactors

Technical Data

			Ex9CA					
			9	12	18	25	32	38
Auxiliary Contact Amperage Ratings								
A600 AC (V)	Make and emergency interrupting capacity (Amp)	120V (A)	60					
		240V (A)	30					
		480V (A)	15					
		600V (A)	12					
	Normal load break (Amp)	120V (A)	6					
		240V (A)	3					
		480V (A)	1.6					
	Thermal current (Amp)	600V (A)	1.2					
			10					
Q600 DC (V)	Make and emergency interrupting capacity (Amp)	125V (A)	0.55					
		250V (A)	0.27					
		440V (A)	0.1					
		600V (A)	0.1					
	Normal load break (Amp)	125V (A)	0.55					
		250V (A)	0.27					
		440V (A)	0.1					
	Thermal current (Amp)	600V (A)	0.1					
			2.5					
Tolerance of Control Voltage								
AC control (50/60 Hz)	pick-up (Operating Voltage)		85...110%					
	dropout (Operating Voltage)		20...75%					
DC control	pick-up (Operating Voltage)		80...110%					
	dropout (Operating Voltage)		10...75%					
Coil Power Consumption								
AC control (50/60 Hz)	pick-up (VA)		120VA (Ex9CA09-18)/140VA (Ex9CA25-38)					
	hold-in (VA)		12VA (Ex9CA09-18)/14VA (Ex9CA25-38)					
DC control	pick-up (W)		≤70					
	hold-in (W)		≤3.5					
Operating Time								
AC	closing delay (ms)		15...30					
	opening delay (ms)		15...25					
DC	closing delay (ms)		100...170					
	opening delay (ms)		30-100					
Typical Lifetime								
B _{10D} Value (Electrical)	DC Coil		1,080,000			1,013,000		
	AC Coil		1,280,000			1,025,000		

Safety Control Relays

Ex9RCA Product Overview

Features

The NOARK Electric Ex9RCA Safety Control Relay is designed to provide fail-safe performance for safety function applications. It features mechanically linked contacts for use on safety feedback circuits with up to 8 contacts. When installed, the normally closed contact is force guided with the normally open contacts, making the Ex9RCA ideal for SRP/CS*.

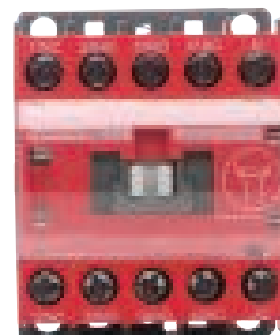

* SRP/CS is the term given by ISO short for safety-related part of a control system, meaning part of a control system that responds to safety-related input signals and generates safety-related output signals

- Force guided/mechanically linked contacts as per IEC/UL 60947-5-1 Annex L
- Mechanically linked contacts symbol prominently displayed on red front cover
- Fixed transparent anti-dust cover allows easy identification of device action and prevents manual operation
- 4-pole models available with AC or DC operating coils
- 8-pole models available DC only
- Easily mounts on DIN 35mm or panel
- 5-years limited warranty



M

Certifications

- UL 508 Listed, File No. E353865, UL 60947-1
- CSA C22.2 No. 14, File No. E353865
- IEC/EN 60947-5-1
- CE Approved
- CCC Certified



Safety Control Relays

Ex9RCA

Green Highlight = Most Popular



Certifications

IEC/EN 60947-4-1



Coil Voltage		4-Pole		
		Catalog Number Contact Configuration 1NO+3NC	Catalog Number Contact Configuration 2NO+2NC	Catalog Number Contact Configuration 3NO+1NC
Vac	120	Ex9RCA13G	Ex9RCA22G	Ex9RCA31G
Vdc	24	Ex9RCADBS	Ex9RCA22DBS	Ex9RCA31DBS



Coil Voltage		8-Pole		
		Catalog Number Contact Configuration 2NO+6NC	Catalog Number Contact Configuration 3NO+5NC	Catalog Number Contact Configuration 4NO+4NC
Vdc	24	Ex9RCA26DBS	Ex9RCA35DBS	Ex9RCA35DBS

Coil Voltage		8-Pole		
		Catalog Number Contact Configuration 5NO+3NC	Catalog Number Contact Configuration 6NO+2NC	Catalog Number Contact Configuration 7NO+1NC
Vdc	24	Ex9RCA53DBS	Ex9RCA62DBS	Ex9RCA71DBS

Additional products, accessories and higher ratings available. Contact your NOARK representative or visit na.noark-electric.com for additional information.

Safety Control Relay

Technical Data

General Information		Ex9RCA	
Poles		4, 8	
Production Standard		UL 60947-5-1, GB/T 14048.5, IEC/EN 60947-5-1	
Rated Operating Voltage (U _e)	AC 50/60 HZ	24, 120	
	DC	24	
Rated Insulating Voltage U _i (V)	IEC	690	
	UL, CSA	600	
Rated Impulse Withstand Voltage U _{imp} (kV)		6	
Electrical Life AC-15 (240V/2A)		1,000,000	
Mechanical Life		10,000,000	
Protection Class		IP20	
Ambient Temperature	Transportation or Storage (°C)	-60...+80	
	Operation at rated voltage (°C)	-20...+60	
Max. Altitude of Installation Site ft (m)		<6,562 (2,000)	
Minimum operating current		8mA/24V	
Contact Ratings		Main and Auxiliary Contacts (A600)	
AC Ratings Maximum Amps (A)	AC Volts (V)	Make	Break
		120	6
		240	3
		480	1.6
	600	1.2	
	Thermal current (Amp)	10	
DC Ratings Maximum Amps (A)	DC Volts (V)	Auxiliary Contacts (Q600)	Power Contacts (P600)
		24	5.0
		48	2.5
		125	1.10
	250	0.55	
301 to 600	0.27	0.20	
	Thermal current (Amp)	2.5	5.0
Load Carrying Capacity per UL			
Rated voltage AC (V)		Max. 600	
Continuous rating 40 °C (A)		10	
Switching capacity AC (A)		A600	
Rated voltage DC (V)		Max. 600	
Switching capacity DC (A)		Auxiliary Contacts Q600	Power Contacts P600
Tolerance of Control Voltage			
AC control (50/60 Hz)	pick-up (x Operating Voltage)	85%...110%	
	dropout (x Operating Voltage)	20%...75%	
DC control	pick-up (x Operating Voltage)	80%...110% (4-Pole), 85%...110%	
	dropout (x Operating Voltage)	10%...75%	
Coil Power Consumption			
AC control(50/60 Hz)	pick-up (VA)	40	
	hold-in (VA)	9	
DC control	pick-up (W)	3.2-4.0	
	hold-in (W)	3.2-4.0	
Operating Time			
AC	closing delay (ms)	15...30	
	opening delay (ms)	15...25	
DC	closing delay (ms)	25-40	
	opening delay (ms)	10...15	



Soft Starter

Product Overview

Features

Ex9QR5 is a solid-state reduced voltage (SSRV) motor starter used in the control and protection of 3-phase electric motors. Its multiple starting modes control the voltage and current applied to the motor to provide soft start, speed ramp and soft stop capability. The Ex9QR5 has built-in motor overload protection in class 10, 20 and 30, along with advanced protection such as phase loss/phase unbalance, undervoltage and more. It is the ideal solution for energy savings and torque control in applications like fans, blowers, pumps, compressors, ball mills, crushers and many other loads.



Ex9QR5 Features:

- Seven unique starting modes
- Automatic light-load energy savings
- Low-speed forward and reverse
- Programmable kickstart mode
- Soft stop and braking
- Sequential, multiple motor starting
- Programmable digital inputs and analog output
- Built-in RS-485 communication interface and standard Modbus protocol
- Separately mountable LCD display with user-friendly interface

Ex9QR5 Ratings:

- 200Vac to 690Vac
- Ampacity ratings from 15A through 1000A in five frame sizes
- Input frequency range from 35Hz to 60Hz

Motor Protection Functions:

- Phase loss/phase unbalance
- Starting current limit timeout
- Undervoltage/Overvoltage
- Output phase loss
- Motor overload
- Load locked/short circuit
- Multi-start lockout

Certifications:

- UL 508 Listed, File No. E533416;
UL 60947-4-2
- CSA C22.2 No. 14; CSA C22.2
No. 60947-4-2



Soft starter Catalog QR Code



Soft Starter Product Page

Soft Starter

Product Selection

Rated Current	Product	Part Number	Description
15A	Ex9QR5-15-6-D	1720000	Soft Starters, Ex9QR5, 15A, 200-690Vac, 100~240 Vac control, Non-Bypassed
22A	Ex9QR5-22-6-D	1720001	Soft Starters, Ex9QR5, 22A, 200-690Vac, 100~240 Vac control, Non-Bypassed
30A	Ex9QR5-30-6-D	1720002	Soft Starters, Ex9QR5, 30A, 200-690Vac, 100~240 Vac control, Non-Bypassed
37A	Ex9QR5-37-6-D	1720003	Soft Starters, Ex9QR5, 37A, 200-690Vac, 100~240 Vac control, Non-Bypassed
44A	Ex9QR5-44-6-D	1720004	Soft Starters, Ex9QR5, 44A, 200-690Vac, 100~240 Vac control, Non-Bypassed
60A	Ex9QR5-60-6-D	1720005	Soft Starters, Ex9QR5, 60A, 200-690Vac, 100~240 Vac control, Non-Bypassed
74A	Ex9QR5-74-6-D	1720006	Soft Starters, Ex9QR5, 74A, 200-690Vac, 100~240 Vac control, Non-Bypassed
90A	Ex9QR5-90-6-D	1720007	Soft Starters, Ex9QR5, 90A, 200-690Vac, 100~240 Vac control, Non-Bypassed
110A	Ex9QR5-110-6-D	1720008	Soft Starters, Ex9QR5, 110A, 200-690Vac, 100~240 Vac control, Non-Bypassed
150A	Ex9QR5-150-6-D	1720009	Soft Starters, Ex9QR5, 150A, 200-690Vac, 100~240 Vac control, Non-Bypassed
180A	Ex9QR5-180-6-D	1720010	Soft Starters, Ex9QR5, 180A, 200-690Vac, 100~240 Vac control, Non-Bypassed
220A	Ex9QR5-220-6-D	1720011	Soft Starters, Ex9QR5, 220A, 200-690Vac, 100~240 Vac control, Non-Bypassed
264A	Ex9QR5-264-6-D	1720012	Soft Starters, Ex9QR5, 264A, 200-690Vac, 100~240 Vac control, Non-Bypassed
320A	Ex9QR5-320-6-D	1720013	Soft Starters, Ex9QR5, 320A, 200-690Vac, 100~240 Vac control, Non-Bypassed
370A	Ex9QR5-370-6-D	1720014	Soft Starters, Ex9QR5, 370A, 200-690Vac, 100~240 Vac control, Non-Bypassed
440A	Ex9QR5-440-6-D	1720015	Soft Starters, Ex9QR5, 440A, 200-690Vac, 100~240 Vac control, Non-Bypassed
500A	Ex9QR5-500-6-D	1720016	Soft Starters, Ex9QR5, 500A, 200-690Vac, 100~240 Vac control, Non-Bypassed
560A	Ex9QR5-560-6-D	1720017	Soft Starters, Ex9QR5, 560A, 200-690Vac, 100~240 Vac control, Non-Bypassed
630A	Ex9QR5-630-6-D	1720018	Soft Starters, Ex9QR5, 630A, 200-690Vac, 100~240 Vac control, Non-Bypassed
710A	Ex9QR5-710-6-D	1720019	Soft Starters, Ex9QR5, 710A, 200-690Vac, 100~240 Vac control, Non-Bypassed
800A	Ex9QR5-800-6-D	1720020	Soft Starters, Ex9QR5, 800A, 200-690Vac, 100~240 Vac control, Non-Bypassed
900A	Ex9QR5-900-6-D	1720021	Soft Starters, Ex9QR5, 900A, 200-690Vac, 100~240 Vac control, Non-Bypassed
1000A	Ex9QR5-1000-6-D	1720022	Soft Starters, Ex9QR5, 1000A, 200-690Vac, 100~240 Vac control, Non-Bypassed

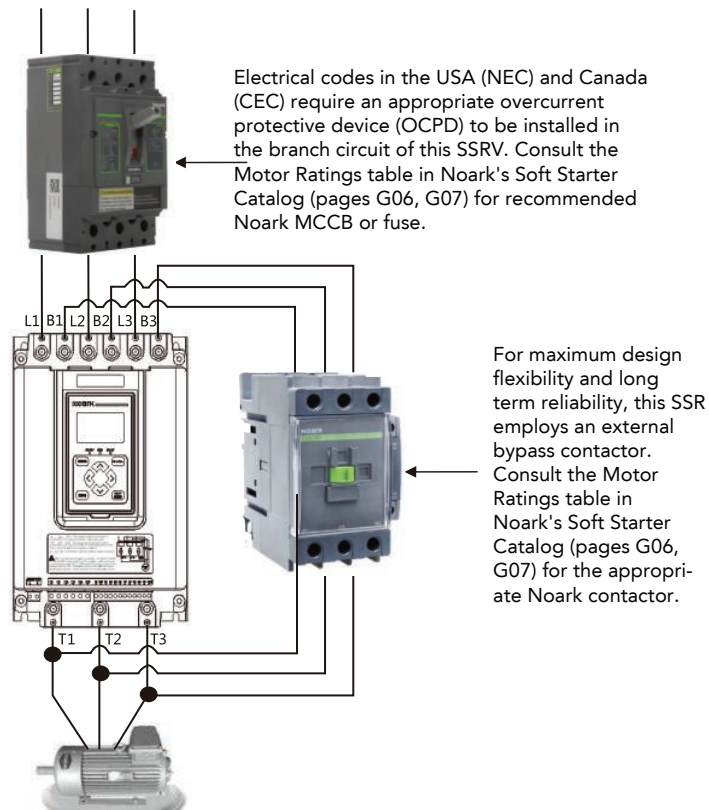

N

Soft Starter

Technical Specifications

Technical data		
Rated Insulation Voltage Ui	800 Vac	
Rated operational voltage Ue	200Vac- 690Vac (-10%~+10%)	
Rated frequency	Current mode(suggested)	35Hz~60Hz
	Other starting mode	50Hz ± 2Hz and 60Hz ± 2Hz
Rated control supply voltage Us	100Vac-240Vac (-10%~+10%)	
Rated control frequency	50Hz ± 2Hz、60Hz ± 2Hz	
Rated Impulse Withstand Voltage Uimp (kV)	8kV	
Initial voltage	30%Ue~70%Ue	
Current Limitation	50%Ie~500%Ie	
General information		
Class of pollution	Level 3	
EMC equipment level	Class A (industrial grade) Level 3	
Shock resistance	less than 0.5g	
Overload class	10A, 10, 20 and 30	
Main circuit		
Built-in bypass	No	
Cooling system	fan cooled	
Ambient temperature		
Storage	-25°C to +70°C	
Working	-10°C to +40°C	full performance
	40°C to +50°C	the current derates 2% for every 1°C
Relative humidity	Not exceed 95%(+20°C to +65°C)	
Altitude ft (m)		
< 1,000m	full performance	
1,000m - 3000m	the current derated 0.5% for every 100m	
> 3,000m	contact Noark for customization	
Control I/O		
Signal relays		
K1	Bypass relay	
K2	Programmable status relay	
K3	Programmable fault relay	
Optional I/O		
IN1	Programmable input terminal	
IN2	Programmable input terminal	
Analog output	Four output types: 4mA~20mA, 0mA~20mA, 2mA~10mA and 0mA~10mA.	
Analog input	Motor Temperature Input (PTC Thermistor)	
Control Inputs		
RUN	Start Input (NO dry contact)	
STOP	Stop Input (NC dry contact)	
EMS	Emergency Stop (NC dry contact)	

* PTC: Positive Temperature Coefficient thermistor

22 mm Pilot Devices

Product Guide

Pushbuttons



Pushbuttons



Selector Switches



Indicator Lights



22 mm Indicator Lights

Ex9IL Product Overview

Features

- UL Recognized component and IP65 rated
- Compact profile and depth
- Operators mount in a round 7/8 in (22.5 mm) hole that is interchangeable with other industry products
- Modular construction makes assembly fast and simple



Certifications

- UL Recognized component, File no. E353866
- CSA C22.2 No. 14, File no. E353866
- IEC/EN 60947
- VDE 0660
- CE Approved



22 mm Indicator Lights

Ex9IL2 Compact Pilot Lights



Certifications
IEC/EN 60947-5-1
CE cUL US



Green Highlight = Most Popular



Resistance Type		
Color	LED Lamp Voltage (Vac/dc)	Catalog Number
●	12	Ex9IL2C3
●	12	Ex9IL2C4
○	24	Ex9IL2D1
●	24	Ex9IL2D3
●	24	Ex9IL2D4
●	24	Ex9IL2D5
●	24	Ex9IL2D6

Capacitance Type		
Color	LED Lamp Voltage (Vac)	Catalog Number
○	110/120	Ex9IL2N1
●	110/120	Ex9IL2N3
●	110/120	Ex9IL2N4
●	110/120	Ex9IL2N5
●	110/120	Ex9IL2N6
●	220/240	Ex9IL2H3
●	220/240	Ex9IL2H4

Specifications

		Ex9IL
Rated Operational Voltage Ue (V)	Vac	12-240
	Vdc	12-24
Rated Operational Current (mA)		le≤20
Service Life (h)		≥30,000
Brightness (cd/m ²)		≥60
Standard Colors		(Green) ● (Red) ●
Other Available Colors		(White)○ (Yellow) ● (Blue) ●

Note: For AC power supply, the limit voltage range is 0.85Ue-1.1Ue between terminals.

Additional products, accessories and higher ratings available. Contact your NOARK representative or visit na.noark-electric.com for additional information.

22 mm Pushbuttons

Ex9PB Product Overview

Features

- Metal construction for superior durability and visual appeal
- UL recognized component and labeled IP40 rated (can be customized into IP65)
- LED replaceable lamps are standard
- Low behind the panel depth
- Operators mount in a round 7/8 in (22.5 mm) hole that is interchangeable with competitor's products
- Field convertible from maintained to momentary (available on maintained pushbuttons only)
- More than one million mechanical operations on momentary and half million on maintained pushbuttons



Certifications

- UL Recognized Component, File No. E353865
- CSA C22.2 No. 14, File no. E353865
- IEC/EN 60947
- VDE 0660
- CE Approved



Specifications

		Ex9PB
Rated Operational Voltage Ue (V)		125
Rated Operational Current (A)	DC-13	0.55
Illuminated Button Lamp Parameters		Direct Type LED Lamp
Rated Operational Current Ie (mA)		Ie≤20
Rated Operational Voltage (V)		6-230 Vac/dc

Note: Conventional thermal current Ith: 10A

22 mm Pushbuttons

Momentary Non-Illuminated



Certifications
IEC/EN 60947-5-1

CE cRU US



Momentary Flush*		
Color	Contacts	Catalog Number
○	1NO	Ex9PBA11
●		Ex9PBA21
●		Ex9PBA31
●		Ex9PBA41
●		Ex9PBA51
●		Ex9PBA61
○	1NC	Ex9PBA12
●		Ex9PBA22
●		Ex9PBA32
●		Ex9PBA42
●		Ex9PBA52
●		Ex9PBA62
○	1NO+1NC	Ex9PBA15
●		Ex9PBA25
●		Ex9PBA35
●		Ex9PBA45
●		Ex9PBA55
●		Ex9PBA65

Momentary Flush+Symbol*		
Color	Contacts	Catalog Number
●	1NO	Ex9PBA3311
●	1NC	Ex9PBA4322



Momentary Extended		
Color	Contacts	Catalog Number
●	1NO	Ex9PBL31
●	1NC	Ex9PBL42

* Ex9PBA momentary flush pushbuttons available up to IP 65. Contact a NOARK representative for more information.



Momentary ø40 mm Mushroom Head		
Color	Contacts	Catalog Number
●	1NO+1NC	Ex9PBC35
●		Ex9PBC45

Momentary ø60 mm Mushroom Head		
Color	Contacts	Catalog Number
●	1NO+1NC	Ex9PBR35
●		Ex9PBR45

Additional products, accessories and higher ratings available. Contact your NOARK representative or visit na.noark-electric.com for additional information.

22 mm Pushbuttons

Momentary and Push On/Twist Off Non-Illuminated



Push On/Twist Off ø30 mm Mushroom Head		
Color	Contacts	Catalog Number
●	1NO	Ex9PBS441
	1NC	Ex9PBS442
	2NO	Ex9PBS443
	2NC	Ex9PBS444
	1NO+1NC	Ex9PBS445

Momentary Double Head - Flush		
Color	Contacts	Catalog Number
● + ●	1NO+1NC	Ex9PBL8325

Push On/Twist Off ø40 mm Mushroom Head		
Color	Contacts	Catalog Number
●	1NO	Ex9PBS541
	1NC	Ex9PBS542
	2NO	Ex9PBS543
	2NC	Ex9PBS544
	1NO+1NC	Ex9PBS545



Momentary Double Head - Extended		
Color	Contacts	Catalog Number
● + ●	1NO+1NC	Ex9PBL8425

Push On/Twist Off ø60 mm Mushroom Head		
Color	Contacts	Catalog Number
●	1NO	Ex9PBS641
	1NC	Ex9PBS642
	2NO	Ex9PBS643
	2NC	Ex9PBS644
	1NO+1NC	Ex9PBS645

Additional products, accessories and higher ratings available. Contact your NOARK representative or visit na.noark-electric.com for additional information.

22 mm Pushbuttons

Selector Switch Non-Illuminated



Certifications
IEC/EN 60947-5-1

CE cULus



Selector Switch - Rotary Knob		
Positions	Contacts	Catalog Number
2-Position		
	1NO+1NC	Ex9PBD25
	1NO+1NC	Ex9PBD45
3-Position		
	2NO	Ex9PBD33
	1NO+1NC	Ex9PBD35
	2NO	Ex9PBD53
	1NO+1NC	Ex9PBD55



Selector Switch - Rotary Handle		
Positions	Contacts	Catalog Number
2-Position		
	1NO+1NC	Ex9PBJ25
	1NO+1NC	Ex9PBJ45
3-Position		
	2NO	Ex9PBJ33
	1NO+1NC	Ex9PBJ35
	2NO	Ex9PBJ53
	1NO+1NC	Ex9PBJ55

Selector Switch - Key		
Positions	Contacts	Catalog Number
2-Position		
	1NO+1NC	Ex9PBG25
	1NO+1NC	Ex9PBG45
3-Position		
	2NO	Ex9PBG33
	1NO+1NC	Ex9PBG35
	2NO	Ex9PBG53
	1NO+1NC	Ex9PBG55
	2NO	Ex9PBG33D
	1NO+1NC	Ex9PBG35D

= Key removed at this position only.

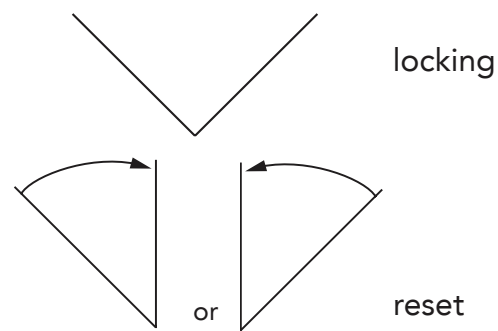

Additional products, accessories and higher ratings available. Contact your NOARK representative or visit na.noark-electric.com for additional information.

22 mm Pushbuttons

Illuminated and Contact Blocks



Certifications
IEC/EN 60947-5-1

CE cRU^{us}



Momentary Flush with Guard		
Color	LED Lamp Voltage Vac/dc	Catalog Number
1NO		
●	24	Ex9PBW3561D
●	24	Ex9PBW3661D
2NO		
●	24	Ex9PBW3363D
●	230	Ex9PBW3363H
1NO+1NC		
●	24	Ex9PBW3365D
●		Ex9PBW3465D
●	110	Ex9PBW3365N
●		Ex9PBW3465N

Momentary Double Head - Flush+Projecting		
Color	Contacts	Catalog Number
1NO+1NC		
● + ●	24	Ex9PBW8465D
	110	Ex9PBW8465N



Indicator Light		
Color	LED Lamp Voltage Vac/dc	Catalog Number
1NO+1NC		
●	24	Ex9PBV63D
●		Ex9PBV64D
●	110	Ex9PBV63N
●		Ex9PBV64N



Contact Blocks		
Accessory Description	Poles	Catalog Number
Contact Block	NO	Ex9PBE101
Contact Block	NC	Ex9PBE102

Additional products, accessories and higher ratings available. Contact your NOARK representative or visit na.noark-electric.com for additional information.

22 mm Pushbutton Accessories

Ex9PB Enclosures



Accessory Description	Catalog Number
Enclosure Start <i>(Pushbuttons included)</i>	Ex9PB101H29
Enclosure Stop/Start Rotary Handle <i>(Pushbuttons included)</i>	Ex9PB132H29



Accessory Description	Catalog Number
Enclosure Start/Stop <i>(Pushbuttons included)</i>	Ex9PB211H29
Enclosure Start/Stop <i>(Pushbuttons included)</i>	Ex9PB213
Enclosure Start/Stop <i>(Pushbuttons included)</i>	Ex9PB215

Appendix A



UL 489 and UL 60947-4-1 (formerly UL 508) Applications

A molded case circuit breaker can be used to provide overload and short circuit protection for cables, control panels, motors and branch circuits. In addition, the National Electrical Code (NEC) requires the following when controlling a motor:



- A means of disconnecting power from the circuit
- Short circuit protection for the cables
- A way to start and stop the motor (typically a contactor)
- Overload protection for the motor (typically an overload relay)

The molded case circuit breaker can provide the means of disconnecting power and provides short circuit protection under UL 60947-4-1 type C protection. The magnetic only Motor Circuit Protector (MCP) can provide the same function under UL 60947-4-1 type D protection.

TYPE C

Components	Catalog Number	Product
Molded Case Circuit Breaker (MCCB)	M1S	
Contactor	EX9C	
Overload Relay	Ex9R	

TYPE D

Components	Catalog Number	Product
Motor Circuit Protector (MCP)	M1M	
Contactor	EX9C	
Overload Relay	Ex9R	

Note: Please refer to (Page 119-124) for series combination ratings for Type C and Type D combination starter types.

Disclaimer: Proper Sizing of an overcurrent protection device is the responsibility of the customer and should be determined using the application standards of the NEC*, CEC**, or other applicable standards.

*NEC-National Electrical Code

** CEC-Canadian Electrical Code

Appendix B

Short Circuit Current Rating Tables

UL60947-4-1 and CSA C22.2 No. 60947-4-1 Short Circuit Current Ratings

UL 60947-4-1 and CSA C22.2 No. 60947-4-1 are the safety standards for industrial control equipment in the USA and Canada. They may be used in place of UL508 and CSA C22.2 No. 14, which are superseded by this harmonized standard.

Establishing the Short Circuit Current Rating (SCCR) of an industrial control panel is an important factor in meeting the requirements of UL 60947-4-1 and its CSA equivalent. This rating establishes the maximum short circuit current that the entire control panel can safely withstand. This required rating is based on the magnitude of the fault current that is available at the control panel's incoming terminals.

The standard defines three separate methods to determine the SCCR of the control panel, based on the individual ratings of the current-carrying components:

- Use the SCCR value marked on each component. The control panel must be labeled with the SCCR value of the lowest-rated component.
- Use assumed SCCR in Table SB4.1 of Supplement SB. The control panel must be labeled with the SCCR value of the lowest rated component.
- Use the tested SCCR from component combinations per UL 508. In this method, individual motor branch circuit components are tested together in specific combinations to achieve a system or "combination" rating. This combination rating is not specifically limited by each individual component rating.

The tables in this Appendix show all the tested combinations of Noark Electric Molded Case Breakers, Motor Contactors and Overload Relays.

UL 60947-4-1 Combination Motor Controllers

UL 60947-4-1 defines the components, product standards, testing and performance requirements for five types of combination motor controller (also called a combination starter) arrangements. Each of these five styles meet the requirements of the NEC and CEC installation codes for motor branch circuit protection. The table below outlines the products and standards used in each combination type.

UL60947-4-1 and CSA C22.2 No. 60947-4-1 Combination Starter Types

Type	Disconnect Device	Short Circuit Protection	Overload Protection	Motor Contoller
A	UL 98 Disconnect Switch	UL 248 Fuses	UL 60947-4-1 Overload Relay (Thermal or Electronic)	UL 60947-4-1 Magnetic Contactor
C	UL 489 Molded Case Breaker (Thermal-Magnetic or Electronic)			
D	UL 489 Motor Circuit Protector (Instantaneous Magnetic Only)		UL 60947-4-1 Overload Relay (Thermal or Electronic)	UL 60947-4-1 Magnetic Contactor
E	UL 60947-4-1 Self-Protected Manual Motor Starter			
F	UL 60947-4-1 Self-Protected Manual Motor Starter			UL 60947-4-1 Magnetic Contactor

Table A1: Type C Short Circuit Current Ratings

200Vac Maximum					
Motor (HP)	FLA (A)	SCCR (kA)	Molded Case Breaker	Contactur	Overload
3	10.6	65	M1N15T3L	Ex9C09...	Ex9R38B... Ex9RE40...
				Ex9C12...	Ex9R38B... Ex9RE40...
		100	M1H15T3L	Ex9C09...	Ex9R38B... Ex9RE40...
				Ex9C12...	Ex9R38B... Ex9RE40...
5	16.7	65	M1N30T3L	Ex9C18...	Ex9R38B... Ex9RE40...
		100	M1H30T3L	Ex9C18...	Ex9R38B... Ex9RE40...
7.5	24.2	65	M1N50T3L	Ex9C25...	Ex9R38B... Ex9RE40...
		100	M1H50T3L	Ex9C25...	Ex9R38B... Ex9RE40...
10	30.8	65	M1N50T3L	Ex9C32...	Ex9R38B... Ex9RE40...
				Ex9C38...	Ex9R38B... Ex9RE40...
		100	M1N70T3L	Ex9C40...	Ex9R100B...
				M1H50T3L	Ex9C32...
Ex9C38...	Ex9R38B... Ex9RE40...				
15	48.3	65	M1N70T3L	Ex9C50...	Ex9R100B...
		100	M1H70T3L		
20	62.1	65	M1N100T3L	Ex9C65...	Ex9R100B...
		100	M1H100T3L		
30	88	65	M1N150T3L	Ex9C100...	Ex9R100B...
		100	M1H150T3L	Ex9C80...	
Ex9C80...					
Ex9C100...					
40	114	65	M2N200T3L	Ex9C115...	Ex9R185B...
		100	M2H200T3L		
50	143	65	M2N200T3L	Ex9C150...	Ex9R185B...
		100	M2H200T3L		
60	169	65	M2N250T3L	Ex9C185...	Ex9R185B...
		100	M2H250T3L	Ex9C225...	Ex9R500B...
Ex9C185...	Ex9R185B...				
Ex9C225...	Ex9R500B...				
75	211	65	M3N400T3L	Ex9C265...	Ex9R500B...
		100	M3H400T3L		
100	273	65	M3N400T3L	Ex9C300...	Ex9R500B...
		100	M3H400T3L		
125	343	65	M4N500T3L	Ex9C400...	Ex9R500B...
		100	M4H500T3L		
150	396	65	M4N600T3L	Ex9C500...	Ex9R500B...
		100	M4H600T3L		

Appendix B

Short Circuit Current Rating Tables

Table A2: Type C Short Circuit Current Ratings					
208Vac Maximum					
Motor (HP)	FLA (A)	SCCR (kA)	Molded Case Breaker	Contactor	Overload Relay
3	11	65	M1N15T3L	Ex9C09...	Ex9R38B... Ex9RE40...
				Ex9C12...	Ex9R38B... Ex9RE40...
		100	M1H15T3L	Ex9C09...	Ex9R38B... Ex9RE40...
				Ex9C12...	Ex9R38B... Ex9RE40...
5	17.5	65	M1N30T3L	Ex9C18...	Ex9R38B... Ex9RE40...
		100	M1H30T3L	Ex9C18...	Ex9R38B... Ex9RE40...
7.5	25.3	65	M1N30T3L	Ex9C25...	Ex9R38B... Ex9RE40...
		100	M1H30T3L	Ex9C25...	Ex9R38B... Ex9RE40...
10	32.2	65	M1N50T3L	Ex9C32...	Ex9R38B... Ex9RE40...
				Ex9C38...	Ex9R38B... Ex9RE40...
		100	M1H50T3L	Ex9C32...	Ex9R38B... Ex9RE40...
				Ex9C38...	Ex9R100B... Ex9R100B...
15	48.3	65	M1N70T3L	Ex9C50...	Ex9R100B...
20	62.1	65	M1N100T3L	Ex9C65...	Ex9R100B...
30	92	65	M1N150T3L	Ex9C80...	Ex9R100B...
				Ex9C100...	
40	120	65	M2N200T3L	Ex9C80...	Ex9R185B...
				Ex9C100...	
50	150	65	M2N200T3L	Ex9C115...	Ex9R185B...
				Ex9C150...	
60	177	65	M2N250T3L	Ex9C150...	Ex9R185B... Ex9R500B...
				Ex9C225...	
75	221	65	M2H250T3L	Ex9C185...	Ex9R185B... Ex9R500B...
				Ex9C225...	
100	285	65	M3N400T3L	Ex9C265...	Ex9R500B...
				Ex9C300...	
125	359	65	M3H400T3L	Ex9C300...	Ex9R500B...
				Ex9C400...	
150	414	65	M4N500T3L	Ex9C400...	Ex9R500B...
				Ex9C500...	
		65	M4N600T3L	Ex9C400...	Ex9R500B...
				Ex9C500...	

Table A3: Type C Short Circuit Current Ratings					
240Vac Maximum					
Motor (HP)	FLA (A)	SCCR (kA)	Molded Case Breaker	Contactor	Overload Relay
3	9.6	65	M1N15T3L	Ex9C09...	Ex9R38B... Ex9RE40...
				Ex9C12...	Ex9R38B... Ex9RE40...
		100	M1H15T3L	Ex9C09...	Ex9R38B... Ex9RE40...
				Ex9C12...	Ex9R38B... Ex9RE40...
5	15.2	65	M1N30T3L	Ex9C18...	Ex9R38B... Ex9RE40...
		100	M1H30T3L	Ex9C18...	Ex9R38B... Ex9RE40...
7.5	22	65	M1N30T3L	Ex9C25...	Ex9R38B... Ex9RE40...
		100	M1H30T3L	Ex9C25...	Ex9R38B... Ex9RE40...
10	28	65	M1N50T3L	Ex9C32...	Ex9R38B... Ex9RE40...
				Ex9C38...	Ex9R38B... Ex9RE40...
		100	M1H50T3L	Ex9C32...	Ex9R38B... Ex9RE40...
				Ex9C38...	Ex9R100B... Ex9R100B...
15	42	65	M1N70T3L	Ex9C40...	Ex9R100B...
20	54	65	M1H70T3L	Ex9C40...	Ex9R100B...
25	68	65	M1N100T3L	Ex9C50...	Ex9R100B...
				Ex9C65...	
30	80	65	M1H100T3L	Ex9C50...	Ex9R100B...
				Ex9C80...	
40	104	65	M1N150T3L	Ex9C65...	Ex9R100B...
				Ex9C100...	
50	130	65	M2N200T3L	Ex9C115...	Ex9R185B...
				Ex9C150...	
60	154	65	M2H200T3L	Ex9C150...	Ex9R185B...
				Ex9C225...	
75	192	65	M2N250T3L	Ex9C185...	Ex9R185B... Ex9R500B...
				Ex9C225...	
100	248	65	M2H250T3L	Ex9C185...	Ex9R185B... Ex9R500B...
				Ex9C225...	
125	312	65	M3N400T3L	Ex9C265...	Ex9R500B...
				Ex9C300...	
150	360	65	M3H400T3L	Ex9C300...	Ex9R500B...
				Ex9C400...	
200	480	65	M4N500T3L	Ex9C400...	Ex9R500B...
				Ex9C500...	
		65	M4N600T3L	Ex9C400...	Ex9R500B...
				Ex9C500...	

Appendix B

Short Circuit Current Rating Tables

Table A4: Type C Short Circuit Current Ratings					
480Vac Maximum					
Motor (HP)	FLA (A)	SCCR (kA)	Molded Case Breaker	Contactors	Overload Relay
5	7.6	35	M1S15T3L	Ex9C09...	Ex9R38B...
		65	M1N15T3L	Ex9C09...	Ex9R38B... Ex9RE40...
		100	M1H15T3L	Ex9C09...	Ex9R38B... Ex9RE40...
7.5	11	35	M1S15T3L	Ex9C12...	Ex9R38B...
		65	M1N15T3L	Ex9C12...	Ex9R38B... Ex9RE40...
		100	M1H15T3L	Ex9C12...	Ex9R38B... Ex9RE40...
10	14	35	M1S30T3L	Ex9C18...	Ex9R38B...
		65	M1N30T3L	Ex9C18...	Ex9R38B... Ex9RE40...
		100	M1H30T3L	Ex9C18...	Ex9R38B... Ex9RE40...
15	21	35	M1S30T3L	Ex9C25...	Ex9R38B...
		65	M1N30T3L	Ex9C25...	Ex9R38B... Ex9RE40...
		100	M1H30T3L	Ex9C25...	Ex9R38B... Ex9RE40...
20	27	35	M1S50T3L	Ex9C32... Ex9C38...	Ex9R38B... Ex9R38B...
			65	M1N50T3L	Ex9C32... Ex9C38...
		100		M1H50T3L	Ex9C32... Ex9C38...
			35		M1S70T3L
		65		M1N70T3L	
		100	M1H70T3L	Ex9C40...	Ex9R100B...
30	40	35	M1S70T3L		
		65	M1N70T3L		
		100	M1H70T3L		
40	52	35	M1S70T3L	Ex9C50...	Ex9R100B...
		65	M1N70T3L		
		100	M1H70T3L		
50	65	35	M1S100T3L	Ex9C65...	Ex9R100B...
		65	M1N100T3L		
		100	M1H100T3L		
60	77	35	M1S100T3L	Ex9C100... Ex9C80...	Ex9R100B...
		100	M1H100T3L	Ex9C100... Ex9C80...	Ex9R100B...
100	124	35	M2S200T3L	Ex9C115...	Ex9R185B...
		65	M2N200T3L		
		100	M2H200T3L		
125	156	35	M2S200T3L	Ex9C150...	Ex9R185B...
		65	M2N200T3L		
		100	M2H200T3L		
150	180	35	M2S250T3L	Ex9C185... Ex9C225...	Ex9R185B...
			65	M2N250T3L	Ex9C185... Ex9C185...
		100		M2H250T3L	Ex9C185... Ex9C225...
			35		M3S400T3L
65	M3N400T3L				
100	M3H400T3L				
200	240	35	M3S400T3L	Ex9C265...	Ex9R500B...
		65	M3N400T3L		
		100	M3H400T3L		
250	302	35	M3S400T3L	Ex9C300...	Ex9R500B...
		65	M3N400T3L		
		100	M3H400T3L		
300	361	35	M4S500T3L	Ex9C400...	Ex9R500B...
		65	M4N500T3L		
		100	M4H500T3L		
400	477	35	M4S600T3L	Ex9C500...	Ex9R500B...
		65	M4N600T3L		
		100	M4H600T3L		

Table A5: Type C Short Circuit Current Ratings							
600Vac Maximum							
Motor (HP)	FLA (A)	SCCR (kA)	Molded Case Breaker	Contactors	Overload Relay		
7.5	9	20	M1N15T3L	Ex9C09...	Ex9RE40...		
		25	M1H15T3L				
10	11	20	M1N15T3L	Ex9C12...	Ex9RE40...		
		25	M1H15T3L				
15	17	20	M1N30T3L	Ex9C18...	Ex9RE40...		
		25	M1H30T3L				
20	22	20	M1N30T3L	Ex9C25...	Ex9RE40...		
		25	M1H30T3L				
25	27	20	M1N50T3L	Ex9C32... Ex9C38...	Ex9RE40...		
		20		Ex9C32... Ex9C38...			
		25	M1H50T3L	Ex9C32... Ex9C38...	Ex9RE40...		
		25		Ex9C32... Ex9C38...			
30	32	20	M1N70T3L	Ex9C40...	Ex9R100B...		
		25	M1H70T3L				
40	41	20	M1N70T3L	Ex9C50...	Ex9R100B...		
		25	M1H70T3L				
50	52	20	M1N70T3L	Ex9C65...	Ex9R100B...		
		25	M1H70T3L				
60	62	20	M1N100T3L	Ex9C100... Ex9C80...	Ex9R100B...		
			25	M1H100T3L		Ex9C100... Ex9C80...	
		125		125	20	M2N200T3L	Ex9C115...
			25		M2H200T3L		
150	144	20	M2N200T3L	Ex9C150...	Ex9R185B...		
			25			M2H200T3L	
		200		192	20	M2N250T3L	Ex9C185... Ex9C225...
			25		M2H250T3L	Ex9C185... Ex9C225...	
250	242	18	M3S400T3L	Ex9C265...	Ex9R500B...		
		25	M3N400T3L				
		30	M3N400T3L				
300	289	18	M3S400T3L	Ex9C300...	Ex9R500B...		
		25	M3S400T3L				
		30	M3H400T3L				
400	382	22	M4S500T3L	Ex9C400...	Ex9R500B...		
		30	M4N500T3L				
		50	M4N500T3L				
500	472	22	M4S600T3L	Ex9C500...	Ex9R500B...		
		30	M4N600T3L				
		50	M4H600T3L				

Appendix B

Short Circuit Current Rating Tables

Table A6: Type D Short Circuit Current Ratings						
200Vac Maximum						
Motor (HP)	FLA (A)	SCCR (kA)	Molded Case Breaker	Contactors	Overload Relay	
3	2.5	65	M1MN3T3L	Ex9C09...	Ex9R38B... Ex9RE40...	
		100	M1MH3T3L	Ex9C09...	Ex9R38B... Ex9RE40...	
	4.8	65	M1MN7T3L	Ex9C09...	Ex9R38B... Ex9RE40...	
		100	M1MH7T3L	Ex9C09...	Ex9R38B... Ex9RE40...	
	7.8	65	M1MN15T3L	Ex9C09... Ex9C12...	Ex9RE40...	
		100	M1MH15T3L	Ex9C09... Ex9C12...	Ex9RE40...	
	11	65	M1MN15T3L	Ex9C09... Ex9C12...	Ex9R38B... Ex9R38B...	
		100	M1MH15T3L	Ex9C09... Ex9C12...	Ex9R38B... Ex9R38B...	
	5	17.5	65	M1MN30T3L	Ex9C18...	Ex9R38B... Ex9RE40...
			100	M1MH30T3L	Ex9C18...	Ex9R38B... Ex9RE40...
	7.5	25.3	65	M1MH50T3L	Ex9C25...	Ex9R38B... Ex9RE40...
			100	M1MH50T3L	Ex9C25...	Ex9R38B... Ex9RE40...
10	32.2	65	M1MN50T3L	Ex9C32... Ex9C38...	Ex9R38B... Ex9RE40... Ex9R38B... Ex9RE40...	
				M1MN70T3L	Ex9C40...	Ex9R100B...
		100	M1MH50T3L	Ex9C32... Ex9C38...	Ex9R38B... Ex9RE40... Ex9R38B... Ex9RE40...	
				M1MH70T3L	Ex9C40...	Ex9R100B...
15	48.3	65 100	M1MN70T3L M1MH70T3L	Ex9C50...	Ex9R100B...	
20	62.1	65 100	M1MN100T3L M1MH100T3L	Ex9C65...	Ex9R100B...	
30	92	65	M1MN150T3L	Ex9C100... Ex9C80...	Ex9R100B...	
				100	M1MH150T3L	Ex9C100... Ex9C80...
40	120	65 100	M2MN250T3L M2MH250T3L	Ex9C115...	Ex9R185B...	
		65 100	M2MN250T3L M2MH250T3L	Ex9C150...	Ex9R185B...	
60	177	65	M2MN250T3L	Ex9C185... Ex9C225...	Ex9R185B... Ex9R500B...	
				100	M2MH250T3L	Ex9C185... Ex9C225...
75	221	65 100	M3MN400T3L M3MH400T3L	Ex9C265...	Ex9R500B...	
		65 100	M3MN400T3L M3MH400T3L	Ex9C300...	Ex9R500B...	
125	359	65 100	M4MN600T3L M4MH600T3L	Ex9C400...	Ex9R500B...	
		65 100	M4MN600T3L M4MH600T3L	Ex9C500...	Ex9R500B...	

Table A7: Type D Short Circuit Current Ratings						
208Vac Maximum						
Motor (HP)	FLA (A)	SCCR (kA)	Molded Case Breaker	Contactors	Overload Relay	
3	2.4	65	M1MN3T3L	Ex9C09...	Ex9R38B... Ex9RE40...	
		100	M1MH3T3L	Ex9C09...	Ex9R38B... Ex9RE40...	
	4.6	65	M1MN7T3L	Ex9C09...	Ex9R38B... Ex9RE40...	
		100	M1MH7T3L	Ex9C09...	Ex9R38B... Ex9RE40...	
	10.6	65	M1MN15T3L	Ex9C09...	Ex9R38B... Ex9RE40...	
			M1MN15T3L	Ex9C12...	Ex9R38B... Ex9RE40...	
	10.6	100	M1MH15T3L	Ex9C09...	Ex9R38B... Ex9RE40...	
			M1MH15T3L	Ex9C12...	Ex9R38B... Ex9RE40...	
	5	16.7	65	M1MN30T3L	Ex9C18...	Ex9R38B... Ex9RE40...
			100	M1MH30T3L	Ex9C18...	Ex9R38B... Ex9RE40...
	7.5	24.2	65	M1MN50T3L	Ex9C25...	Ex9R38B... Ex9RE40...
			100	M1MH50T3L	Ex9C25...	Ex9R38B... Ex9RE40...
10	30.8	65	M1MN50T3L	Ex9C32... Ex9C38...	Ex9R38B... Ex9RE40... Ex9R38B... Ex9RE40...	
				M1MN70T3L	Ex9C40...	Ex9R100B...
		100	M1MH50T3L	Ex9C32... Ex9C38...	Ex9R38B... Ex9RE40... Ex9R38B... Ex9RE40...	
				M1MH70T3L	Ex9C40...	Ex9R100B...
15	46.2	65 100	M1MN70T3L M1MH70T3L	Ex9C50...	Ex9R100B...	
20	59.4	65 100	M1MN100T3L M1MH100T3L	Ex9C65...	Ex9R100B...	
30	88	65 100	M1MN150T3L M1MH150T3L	Ex9C100... Ex9C80...	Ex9R100B... Ex9R100B...	
		65 100	M2MN250T3L M2MH250T3L	Ex9C115...	Ex9R185B...	
40	114	65 100	M2MN250T3L M2MH250T3L	Ex9C150...	Ex9R185B...	
		65 100	M2MN250T3L M2MH250T3L	Ex9C185... Ex9C225...	Ex9R185B... Ex9R500B...	
60	169	65 100	M2MN250T3L M2MH250T3L	Ex9C185... Ex9C225...	Ex9R185B... Ex9R500B...	
		65 100	M3MN400T3L M3MH400T3L	Ex9C265...	Ex9R500B...	
100	273	65 100	M3MN400T3L M3MH400T3L	Ex9C300...	Ex9R500B...	
		65 100	M4MN600T3L M4MH600T3L	Ex9C400...	Ex9R500B...	
150	396	65 100	M4MN600T3L M4MH600T3L	Ex9C500...	Ex9R500B...	

Appendix B

Short Circuit Current Rating Tables

Table A8: Type D Short Circuit Current Ratings					
240Vac Maximum					
Motor (HP)	FLA (A)	SCCR (kA)	Molded Case Breaker	Contactors	Overload Relay
3	2.2	65	M1MN3T3L	Ex9C09...	Ex9R38B...
		100	M1MH3T3L		
	6	65	M1MN7T3L	Ex9C09...	
		100	M1MH7T3L		
	9.6	65	M1MN15T3L	Ex9C09...	
		100	M1MH15T3L	Ex9C12... Ex9C09... Ex9C12...	
5	15.2	65	M1MN30T3L	Ex9C18...	Ex9R38B...
		100	M1MH30T3L		
7.5	22	65	M1MN30T3L	Ex9C25...	Ex9R38B...
		100	M1MH30T3L		
10	28	65	M1MN50T3L	Ex9C32... Ex9C38...	Ex9R38B...
		100	M1MH50T3L	Ex9C32... Ex9C38...	
		100	M1MH50T3L	Ex9C38...	
15	42	65	M1MN70T3L	Ex9C40...	Ex9R100B...
		100	M1MH70T3L		
20	54	65	M1MN70T3L	Ex9C50...	Ex9R100B...
		100	M1MH70T3L		
25	68	65	M1MN100T3L	Ex9C65...	Ex9R100B...
		100	M1MH100T3L		
30	80	65	M1MN100T3L	Ex9C80...	Ex9R100B...
		100	M1MH100T3L		
40	104	65	M1MN150T3L	Ex9C100...	Ex9R100B...
		100	M1MH150T3L		
50	130	65	M2MN250T3L	Ex9C115...	Ex9R185B...
		100	M2MH250T3L		
60	154	65	M2MN250T3L	Ex9C150...	Ex9R185B...
		100	M2MH250T3L		
75	192	65	M2MN250T3L	Ex9C185... Ex9C225...	Ex9R185B... Ex9R500B...
		100	M2MH250T3L	Ex9C225... Ex9C225...	Ex9R185B... Ex9R500B...
		100	M2MH250T3L	Ex9C225...	Ex9R500B...
100	248	65	M3MN400T3L	Ex9C265...	Ex9R500B...
		100	M3MH400T3L		
125	312	65	M3MN400T3L	Ex9C300...	Ex9R500B...
		100	M3MH400T3L		
150	360	65	M4MN600T3L	Ex9C400...	Ex9R500B...
		100	M4MH600T3L		
200	480	65	M4MN600T3L	Ex9C500...	Ex9R500B...
		100	M4MH600T3L		

Table A9: Type D Short Circuit Current Ratings					
480Vac Maximum					
Motor (HP)	FLA (A)	SCCR (kA)	Molded Case Breaker	Contactors	Overload Relay
5	2.1	35	M1MS3T3L	Ex9C09...	Ex9R38B...
		65	M1MN3T3L	Ex9C09...	Ex9R38B... Ex9RE40...
		100	M1MH3T3L	Ex9C09...	Ex9R38B... Ex9RE40...
	4.8	35	M1MS7T3L	Ex9C09...	Ex9R38B...
		65	M1MN7T3L	Ex9C09...	Ex9R38B... Ex9RE40...
		100	M1MH7T3L	Ex9C09...	Ex9R38B... Ex9RE40...
7.6	35	M1MS15T3L	Ex9C09...	Ex9R38B...	
	65	M1MN15T3L	Ex9C09...	Ex9R38B... Ex9RE40...	
	100	M1MH15T3L	Ex9C09...	Ex9R38B... Ex9RE40...	
7.5	11	35	M1MS15T3L	Ex9C12...	Ex9R38B...
		65	M1MN15T3L	Ex9C12...	Ex9R38B... Ex9RE40...
		100	M1MH15T3L	Ex9C12...	Ex9R38B... Ex9RE40...
10	14	35	M1MS30T3L	Ex9C18...	Ex9R38B...
		65	M1MN30T3L	Ex9C18...	Ex9R38B... Ex9RE40...
		100	M1MH30T3L	Ex9C18...	Ex9R38B... Ex9RE40...
15	21	35	M1MS30T3L	Ex9C25...	Ex9R38B...
		65	M1MN30T3L	Ex9C25...	Ex9R38B... Ex9RE40...
		100	M1MH30T3L	Ex9C25...	Ex9R38B... Ex9RE40...
20	27	35	M1MS50T3L	Ex9C32... Ex9C38...	Ex9R38B...
		65	M1MN50T3L	Ex9C32... Ex9C38...	Ex9R38B... Ex9RE40... Ex9R38B... Ex9RE40...
		100	M1MH50T3L	Ex9C32... Ex9C38...	Ex9R38B... Ex9RE40... Ex9R38B... Ex9RE40...
30	40	35	M1MS70T3L	Ex9C40...	Ex9R100B...
		65	M1MN70T3L		
		100	M1MH70T3L		
40	52	35	M1MS70T3L	Ex9C50...	Ex9R100B...
		65	M1MN70T3L		
		100	M1MH70T3L		
50	65	35	M1MS100T3L	Ex9C65...	Ex9R100B...
		65	M1MN100T3L		
		100	M1MH100T3L		
60	77	35	M1MS100T3L	Ex9C100... Ex9C80...	Ex9R100B...
		65	M1MN100T3L	Ex9C100... Ex9C80...	
		100	M1MH100T3L	Ex9C100... Ex9C80...	
100	124	35	M2MS250T3L	Ex9C115...	Ex9R185B...
		65	M2MN250T3L		
		100	M2MH250T3L		
125	156	35	M2MS250T3L	Ex9C150...	Ex9R185B...
		65	M2MN250T3L		
		100	M2MH250T3L		
150	180	35	M2MS250T3L	Ex9C185... Ex9C225...	Ex9R185B... Ex9R500B...
			M2MN250T3L	Ex9C185... Ex9C225...	Ex9R185B... Ex9R500B...
			M2MN250T3L	Ex9C185... Ex9C225...	Ex9R185B... Ex9R500B...
200	240	35	M3MS400T3L	Ex9C265...	Ex9R500B...
		65	M3MN400T3L		
		100	M3MH400T3L		
250	302	35	M3MS400T3L	Ex9C300...	Ex9R500B...
		65	M3MN400T3L		
		100	M3MH400T3L		
300	361	35	M4MS600T3L	Ex9C400...	Ex9R500B...
		65	M4MN600T3L		
		100	M4MH600T3L		
400	477	35	M4MS600T3L	Ex9C500...	Ex9R500B...
		65	M4MN600T3L		
		100	M4MH600T3L		



Appendix B

Short Circuit Current Rating Tables

Table A10: Type D Short Circuit Current Ratings					
600Vac Maximum					
Motor (HP)	FLA (A)	SCCR (kA)	Molded Case Breaker	Contactors	Overload Relay
7.5	2.4	20	M1MN3T3L	Ex9C09...	Ex9RE40...
		25	M1MH3T3L		
	3.9	20	M1MN7T3L		
		25	M1MH7T3L		
	9	20	M1MN15T3L		
		25	M1MH15T3L		
10	11	20	M1MN15T3L	Ex9C12...	Ex9RE40...
		25	M1MH15T3L		
15	17	20	M1MN30T3L	Ex9C18...	Ex9RE40...
		25	M1MH30T3L		
20	22	20	M1MN30T3L	Ex9C25...	Ex9RE40...
		25	M1MH30T3L		
25	27	20	M1MN50T3L	Ex9C32...	Ex9RE40...
		20	M1MN50T3L	Ex9C38...	
		25	M1MH50T3L	Ex9C32...	
		25	M1MH50T3L	Ex9C38...	
30	32	20	M1MN70T3L	Ex9C40...	Ex9R100B...
		25	M1MH70T3L		
40	41	20	M1MN70T3L	Ex9C50...	Ex9R100B...
		25	M1MH70T3L		
50	52	20	M1MN70T3L	Ex9C65...	Ex9R100B...
		25	M1MH70T3L		
60	62	20	M1MN100T3L	Ex9C100...	Ex9R100B...
			M1MN100T3L	Ex9C80...	
		25	M1MH100T3L	Ex9C100...	
			M1MH100T3L	Ex9C80...	
125	125	20	M2MN250T3L	Ex9C115...	Ex9R185B...
		25	M2MH250T3L		
150	144	20	M2MN250T3L	Ex9C150...	Ex9R185B...
		25	M2MH250T3L		
200	192	20	M2MN250T3L	Ex9C185...	Ex9R185B...
			M2MN250T3L	Ex9C225...	Ex9R500B...
		25	M2MH250T3L	Ex9C185...	Ex9R185B...
			M2MH250T3L	Ex9C225...	Ex9R500B...
250	242	18	M3MS400T3L	Ex9C265...	Ex9R500B...
		25	M3MN400T3L		
		30	M3MH400T3L		
300	289	18	M3MS400T3L	Ex9C300...	Ex9R500B...
		25	M3MN400T3L		
		30	M3MH400T3L		
400	382	22	M4MS600T3L	Ex9C400...	Ex9R500B...
		30	M4MN600T3L		
		50	M4MH600T3L		
500	472	30	M4MN600T3L	Ex9C500...	Ex9R500B...
		50	M4MH600T3L		

Appendix C

Terms and Conditions of Sale

1. General.

The terms and conditions contained herein, together with any additional or different terms contained in NOARK's Proposal ("Terms"), if any, submitted to Purchaser (which Proposal shall control over any conflicting terms), constitute the entire agreement (the "Agreement") between the parties with respect to the order and supersede all prior communications and agreements regarding the order. Acceptance by NOARK of the order, or Purchaser's acceptance of NOARK's Proposal, is expressly limited to and conditioned upon Purchaser's acceptance of these terms and conditions, payment for or acceptance of any performance by NOARK being acceptance. These terms and conditions may not be changed or superseded by any different or additional terms and conditions proposed by Purchaser to which terms NOARK hereby objects. Unless the context otherwise requires, the term "Equipment" as used herein means all of the equipment, parts, and accessories sold.

2. Prices.

- (a) Unless otherwise specified in writing, all Proposals expire thirty (30) days from the date thereof.
- (b) Prices and other information shown in any NOARK publication (including product catalogs and brochures) are subject to change without notice and to confirmation by specific quotation. Such publications are not offers to sell and are maintained only as a source of general information.
- (c) The price does not include any federal, state or local property, license, privilege, sales, use, transportation, excise, gross receipts, disposal, or other like taxes which may now or hereafter be applicable. Purchaser agrees to pay or reimburse any such taxes which NOARK or its suppliers are required to pay or collect. If Purchaser is exempt from the payment of any tax or holds a direct payment permit, Purchaser shall, upon order placement, provide NOARK a copy, acceptable to the relevant governmental authorities of any such certificate or permit.
- (d) For products shipped from Noark's North America-based warehouses, the price includes customs duties and other importation or exportation fees, if any, at the rates in effect on the date of NOARK's Proposal. Any change after that date in such duties, fees, or rates, shall increase the price by NOARK's additional cost.
- (e) For products shipped from outside of North America, the responsibility for payment of customs duties and other importation or exportation fees will be determined by the shipment terms (Incoterms 2020) listed in the specific quotation issued by Noark.
- (f) NOARK may increase Prices, change transportation terms, change payment terms, and/or change the notice provision, by giving Purchaser at least (15) days prior notice. These changes will be deemed accepted unless Purchaser objects in writing before the effective date of the change. NOARK shall advise Purchaser within fifteen (15) days from receipt of timely written objection from Purchaser whether NOARK shall:
 - (i) continue to supply the Equipment on terms and conditions in effect prior to the announced change.
 - (ii) Enter into negotiations with Purchaser; or
 - (iii) delete affected Equipment from these Terms.

3. Payment.

- (a) Unless specified to the contrary in writing by NOARK, payment terms are net cash, payable without offset, in the invoiced currency, 30 days from date of invoice by wire transfer to the account designated by NOARK in the Proposal. Time of payment is of the essence.
- (b) If in the judgment of NOARK the financial condition of Purchaser at any time prior to delivery does not justify the terms of payment specified, NOARK may require payment in advance, payment security satisfactory to NOARK, or may delay or terminate the order, whereupon NOARK shall be entitled to receive reasonable cancellation charges. If at the request of Purchaser, delivery is to be delayed, payment shall be due on the date NOARK is prepared to make delivery and may be subject to storage costs by NOARK. Delays in delivery or nonconformities in any installments delivered shall not relieve Purchaser of its obligation to accept and pay for remaining installments.
- (c) Purchaser shall pay, in addition to the overdue payment, a late charge equal to the lesser of 1 1/2% per month or any part thereof or the highest applicable rate allowed by law on all such overdue amounts plus NOARK's attorneys' fees and court costs incurred in connection with collection.

4. Minimum Orders

\$250 minimum order. \$25 minimum order fee will be added to any orders less than \$250. Minimum order quantities also apply Minimum Order Fee waived if for emergency air shipments.

5. Changes.

- (a) Any changes requested by Purchaser affecting the ordered scope of work must be accepted by NOARK and resulting adjustments to affected provisions, including price, schedule, and guarantees mutually agreed in writing prior to implementation of the change.
- (b) NOARK may, at its expense, make such changes in the Equipment as it deems necessary, in its sole discretion, to conform the Equipment to the applicable specifications. If Purchaser objects to any such changes, NOARK shall be relieved of its obligation to conform to the applicable specifications to the extent that conformance may be affected by such objection.

6. Delivery.

- (a) All Equipment manufactured, assembled or warehoused in the continental United States or Canada is delivered F.O.B. point of shipment. Equipment shipped from outside the continental United States or Canada is delivered FOB NOARK's factory location unless specified otherwise in the specific quotation. (if not FOB factory, we quote DDP or DDU and charge for transportation, duties etc.). Purchaser shall be responsible for any and all demurrage or detention charges.
- (b) If the scheduled delivery of Equipment is delayed by Purchaser or by Force Majeure, NOARK may move the Equipment to storage for the account of and at the risk of Purchaser whereupon it shall be deemed to be delivered.
- (c) Shipping and delivery dates are contingent upon Purchaser's timely approvals and delivery by Purchaser of any documentation required for NOARK's performance hereunder. Delivery dates are approximate and are dependent upon prompt receipt by Purchaser of all information necessary to proceed with the work without interruption.
- (d) Claims for shortages or other errors in delivery must be made in writing to NOARK within ten days of delivery. Equipment may not be returned except with the prior written consent of and subject to terms specified by NOARK. Claims for damage after delivery shall be made directly by Purchaser with the common carrier.
- (e) Purchaser shall promptly unload and promptly return all transportation equipment to carrier and in no event later than the carrier's rules tariff or contracted period, free of detention charges. Carrier or NOARK may collect carrier's standard detention charge from Purchaser if held beyond carrier's allowable time. When Equipment is to be shipped by barge, vessels, or rail, an addendum containing additional terms and conditions applicable to such shipment will be made a part of these Terms. Purchaser will take reasonable steps to preserve claims for loss or damage in transit against carrier.

7. **Title & Risk of Loss.** Title to Equipment and Risk of Loss will be governed by freight terms (Incoterms 2020) noted in the NOARK quotation.

8. Inspection, Testing and Acceptance.

- (a) Any inspection by Purchaser of Equipment on NOARK's premises shall be scheduled in advance to be performed during normal working hours.
- (b) If the order provides for factory acceptance testing, NOARK shall notify Purchaser when NOARK will conduct such testing prior to shipment. Unless Purchaser states specific objections in writing within ten (10) days after completion of factory acceptance testing, completion of the acceptance test constitutes Purchaser's factory acceptance of the Equipment and its authorization for shipment.
- (c) If the order provides for site acceptance testing, testing will be performed by NOARK personnel to verify that the Equipment has arrived at site complete, without physical damage, and in good operating condition. Completion of site acceptance testing constitutes full and final acceptance of the Equipment. If, through no fault of NOARK, acceptance testing is not completed within thirty (30) days after arrival of the Equipment at the site, the site acceptance test shall be deemed completed and the Equipment shall be deemed accepted.
- (d) Purchaser shall promptly, and in any event prior to use or commingling, inspect the Product shipments for any damage to packaging, shortage or non-conformance to these Terms. All claims for damage to packaging, shortage or non-conformance which could reasonably be discoverable in the course of such investigation shall be waived unless Purchaser notifies NOARK in accordance with this Section.

9. Warranties and Remedies.

- (a) New Component Warranty. NOARK warrants that new Products furnished hereunder will be free from defects in material, workmanship and design for a period of one (1) year or five (5) years as indicated in the table below, from the date of invoice from NOARK or its appointed distributor. Remedies under the above warranties will be limited, at Seller's option, to the replacement, repair, or issuance of a credit for the purchase price, of the Products involved, and only after the return of such Products pursuant to Seller's instructions. The foregoing will be the exclusive remedies for any breach of warranty or breach of contract arising therefrom.

Appendix C

Terms and Conditions of Sale

Product Name	Product Family	Warrant Period
Molded Case Circuit Breakers	M1 to M6 Series	Five (5) years
Miniature Circuit Breakers	B1 Series	
IEC Motor Controllers and Overload Relays (HD)	Ex9C, Ex9CS, Ex9RD, Ex9RE, Ex9S32 Series	
Safety Contactors and Relays	Ex9RCA, Ex9CA	
Pilot Lights, Pushbuttons and Selector Switches	Ex9IL, Ex9PB Series	
Enclosed Breakers	All	
Definite Purpose Contactors	Ex9CK, Ex9CKT Series	
Power Circuit Breakers	A16, A25, A32, A40 Series	One (1) year
IEC Motor Controllers and overload Relays (GP)	Ex9CD, Ex9CM, Ex9R, Ex9S25 Series	
Soft Starts	Ex9QR5 Series	
Any additional products Seller may offer for sale that are not specifically named here		

Warranty satisfaction is available only if (a) Seller is provided prompt written notice of the warranty claim and (b) Seller's examination discloses that any alleged defect has not been caused by misuse; neglect; improper installation, operation, maintenance, repair, alteration or modification by other than Seller; accident; or unusual deterioration or degradation of the Products or parts thereof due to physical environment or electrical or electromagnetic noise environment.

(b) Equipment Warranty. NOARK warrants that Equipment shall be delivered free of defects in material and workmanship. The Warranty Remedy Period for Equipment (excluding Spare Parts and Refurbished or Repaired Parts) shall end twelve (12) months after installation or eighteen (18) months after date of shipment, whichever first occurs. The Warranty Remedy Period for new spare parts shall end twelve (12) months after date of shipment. The Warranty Remedy Period for refurbished or repaired parts shall end ninety (90) days after date of shipment.

(c) Equipment Remedy. If a nonconformity to the foregoing warranty is discovered in the Equipment during the applicable Warranty Remedy Period, as specified above, under normal and proper use and provided the Equipment has been properly stored, installed, operated and maintained and written notice of such nonconformity is provided to NOARK promptly after such discovery and within the applicable Warranty Remedy Period, NOARK shall, at its option, either (i) repair or replace the nonconforming portion of the Equipment or (ii) refund the portion of the price applicable to the nonconforming portion of Equipment. If any portion of the Equipment so repaired, replaced or re-performed fails to conform to the foregoing warranty, and written notice of such nonconformity is provided to NOARK promptly after discovery and within the original Warranty Remedy Period applicable to such Equipment or 30 days from completion of such repair, replacement or re-performance, whichever is later, NOARK will repair or replace such nonconforming Equipment. The original Warranty Remedy Period shall not otherwise be extended.

(d) Exceptions. NOARK shall not be responsible for providing working access to the nonconforming Equipment, including disassembly and re-assembly of non-NOARK supplied equipment, or for providing transportation to or from any repair facility, all of which shall be at Purchaser's risk and expense. NOARK shall have no obligation hereunder with respect to any Equipment which (i) has been improperly repaired or altered; (ii) has been subjected to misuse, negligence or accident; (iii) has been used in a manner contrary to NOARK's instructions; (iv) is comprised of materials provided by or a design specified by Purchaser; or (v) has failed as a result of ordinary wear and tear. Equipment supplied by NOARK but manufactured by others is warranted only to the extent of the manufacturer's warranty, and only the remedies, if any, provided by the manufacturer will be allowed.

(e) THE FOREGOING WARRANTIES ARE EXCLUSIVE AND IN LIEU OF ALL OTHER WARRANTIES OF QUALITY AND PERFORMANCE PROVIDED BY STATUTE, COMMON LAW OR OTHERWISE, WHETHER WRITTEN, ORAL OR IMPLIED, AND ALL OTHER WARRANTIES INCLUDING ANY IMPLIED WARRANTIES OF MERCHANTABILITY OR FITNESS FOR A PARTICULAR PURPOSE OR USAGE OF TRADE ARE HEREBY DISCLAIMED. THE REMEDIES STATED HEREIN CONSTITUTE PURCHASER'S EXCLUSIVE REMEDIES AND NOARK'S ENTIRE LIABILITY FOR ANY BREACH OF WARRANTY.

10. Indemnity.

- (a) NOARK shall defend at its own expense any action brought against Purchaser alleging that the Equipment or the use of the Equipment to practice any process for which such Equipment is specified by NOARK (a "Process") directly infringes any claim of a patent of the United States of America and to pay all damages and costs finally awarded in any such action, provided that Purchaser has given NOARK prompt written notice of such action, all necessary assistance in the defense thereof and the right to control all aspects of the defense thereof including the right to settle or otherwise terminate such action in behalf of Purchaser.
- (b) NOARK shall have no obligation hereunder and this provision shall not apply to: (i) any other equipment or processes, including Equipment or Processes which have been modified or combined with other equipment or process not supplied by NOARK; (ii) any Equipment or Process supplied according to a design, other than an NOARK design, required by Purchaser; (iii) any products manufactured by the Equipment or Process; (iv) any patent issued after the date hereof; or (v) any action settled or otherwise terminated without the prior written consent of NOARK.
- (c) If, in any such action, the Equipment is held to constitute an infringement, or the practice of any Process using the Equipment is finally enjoined, NOARK shall, at its option and its own expense, procure for Purchaser the right to continue using said Equipment; or modify or replace it with non-infringing equipment or, with Purchaser's assistance, modify the Process so that it becomes non-infringing; or remove it and refund the portion of the price allocable to the infringing Equipment. THE FOREGOING PARAGRAPHS STATE THE ENTIRE LIABILITY OF NOARK AND EQUIPMENT MANUFACTURER FOR ANY PATENT INFRINGEMENT.
- (d) To the extent that said Equipment or any part thereof is modified by Purchaser, or combined by Purchaser with equipment or processes not furnished hereunder (except to the extent that NOARK is a contributory infringer) or said Equipment or any part thereof is used by Purchaser to perform a process not furnished hereunder by NOARK or to produce an article, and by reason of said modification, combination, performance or production, an action is brought against NOARK, Purchaser shall defend and indemnify NOARK in the same manner and to the same extent that NOARK would be obligated to indemnify Purchaser under this "Patent Indemnity" provision.
- (e) Notwithstanding the above (a) through (d), Purchaser shall defend, indemnify, and hold NOARK harmless from and against all claims, liabilities, costs and expenses (including, but not limited to, those related to injury to or death of Purchaser's employees, and including prompt payment of reasonably legal fees) arising from or connected with any third party claims related to injury to or death of any person or persons, or damage to or loss of property in any way arising from or connected with the possession, handling, processing or use of the Equipment by Purchaser, except those resulting solely from the use of the Equipment not conforming to the contracted Specifications, which non-conformity was not known to Purchaser.

11. Limitation of Liability.

- (a) In no event shall NOARK, its suppliers or subcontractors be liable for special, indirect, incidental or consequential damages, whether in contract, warranty, tort, negligence, strict liability or otherwise, including, but not limited to, loss of profits or revenue, loss of use of the Equipment or any associated equipment, cost of capital, cost of substitute equipment, facilities or downtime costs, delays, and claims of customers of the Purchaser or other third parties for any damages. NOARK's liability for any claim whether in contract, warranty, tort, negligence, strict liability, or otherwise for any loss or damage arising out of, connected with, or resulting from this Agreement or the performance or breach thereof, or from the design, manufacture, sale, delivery, resale, repair, replacement, installation, technical direction of installation, inspection, operation or use of any equipment covered by or furnished under this Agreement, shall in no case (except as provided in the section entitled "Patent Indemnity") exceed one-half (1/2) of the purchase price allocable to the Equipment or part thereof which gives rise to the claim.

Appendix C

Terms and Conditions of Sale

(b) All causes of action against NOARK arising out of or relating to this Agreement or the performance or breach hereof shall expire unless brought within one year of the time of accrual thereof.
 (c) In no event, regardless of cause, shall NOARK be liable for penalties or penalty clauses of any description or for indemnification of Purchaser or others for costs, damages, or expenses arising out of or related to the Equipment.

12. Disputes

The parties shall attempt in good faith promptly to resolve any dispute arising hereunder by negotiations between representatives of the parties who have authority to settle the dispute. If unsuccessful, the parties further shall attempt in good faith to settle the dispute by non-binding third-party mediation, with mediator fees and expenses apportioned equally to each side. Any dispute not so resolved by negotiation or mediation will then be submitted to a court of competent jurisdiction in accordance with the terms hereof. These procedures are the exclusive procedures for the resolution of all such disputes between the parties.

13. Laws and Regulations.

NOARK does not assume any responsibility for compliance with federal, state or local laws and regulations, except as expressly set forth herein, and compliance with any laws and regulations relating to the operation or use of the Equipment is the sole responsibility of the Purchaser. All laws and regulations referenced herein shall be those in effect as of the Proposal date. In the event of any subsequent revisions or changes thereto, NOARK assumes no responsibility for compliance therewith. If Purchaser desires a modification as a result of any such change or revision, it shall be treated as a change per Article 5. Nothing contained herein shall be construed as imposing responsibility or liability upon NOARK for obtaining any permits, licenses or approvals from any agency required in connection with the supply, erection or operation of the Equipment. This Agreement shall be governed by and interpreted in accordance with the laws, rules and regulation of the jurisdiction and/or forum in which Seller's principal place of business resides. The parties will be subject to the exclusive jurisdiction and venue of state or federal court in which Seller's Principal place of business resides, but specifically excluding the provisions of the 1980 United Nations Convention on Contracts for the International Sales of Goods (Vienna, 11 April 1980 and any successor thereto). If any provision hereof, partly or completely, shall be held invalid or unenforceable, such invalidity or unenforceability shall not affect any other provision or portion hereof and these terms shall be construed as if such invalid or unenforceable provision or portion thereof had never existed. Each party represents and warrants that it understands and shall comply with the requirements of the U.S. Foreign Corrupt Practices Act and all other applicable anti-bribery and anti-corruption laws of the jurisdictions under which each party is or may be acting hereunder.

14. Inventions and Information.

Unless otherwise agreed in writing by NOARK and Purchaser, all right, title and interest in any inventions, developments, improvements or modifications of or for Equipment shall remain with NOARK. Any design, manufacturing drawings or other information submitted to the Purchaser remains the exclusive property of NOARK. Purchaser shall not, without NOARK's prior written consent, copy or disclose such information to a third party. Such information shall be used solely for the operation or maintenance of the Equipment and not for any other purpose, including the duplication thereof in whole or in part. Purchaser shall not use in any manner any trade names or trademarks applied to or used by NOARK with respect to any Equipment, unless otherwise agreed by NOARK in writing.

15. Force Majeure. NOARK shall neither be liable for loss, damage, detention or delay nor be deemed to be in default for failure to perform when prevented from doing so by causes beyond its reasonable control including but not limited to acts of war (declared or undeclared), Acts of God, fire, strike, labor difficulties, acts or omissions of any governmental authority or of Purchaser, compliance with government regulations, insurrection or riot, embargo, delays or shortages in transportation or inability to obtain necessary labor, materials, or manufacturing facilities from usual sources or from defects or delays in the performance of its suppliers or subcontractors due to any of the foregoing enumerated causes. In the event of delay due to any such cause, the date of delivery will be extended by period equal to the delay plus a reasonable time to resume production, and the price will be adjusted to compensate NOARK for such delay.

16. Cancellation. Cancellation by Buyer prior to shipment is permitted only by written notice and upon payment to Seller of reasonable cancellation and restocking charges, including reimbursement for direct costs. Unless specified to the contrary in the quote/proposal, cancellation charges associated with orders for custom Products or Products specifically manufactured to Buyer's specification may equal the actual selling price of the Products, as indicated by the table below. Seller has the right to cancel an order for cause at any time by written notice, and Seller will be entitled to cancellation and restocking charges as identified above.

After receipt of order or before approval drawings are completed-----	15%
After approval drawing completion, but before release to manufacturing-----	30%
Before start of fabrication, but after major component purchase-----	60%
After start of fabrication, but before start of assembly-----	80%
After assembly has started-----	100%

17. Termination.

No termination by Buyer for cause will be effective unless and until Seller has failed to correct such alleged cause within forty-five (45) days after receipt of Buyer's written notice specifying such cause.

18. Export Control.

(a) Purchaser represents and warrants that the Equipment provided hereunder, and the "direct product" thereof are intended for civil use only and will not be used, directly or indirectly, for the production of chemical or biological weapons or of precursor chemicals for such weapons, or for any direct or indirect nuclear end use. Purchaser agrees not to disclose, use, export or re-export, directly or indirectly, any information provided by NOARK, or the "direct product" thereof as defined in the Export Control Regulations of the United States Department of Commerce, except in compliance with such Regulations.

(b) If applicable, NOARK shall file for a U.S. export license, but only after appropriate documentation for the license application has been provided by Purchaser. Purchaser shall furnish such documentation within a reasonable time after order acceptance. Any delay in obtaining such license shall suspend performance of this Agreement by NOARK. If an export license is not granted or, if once granted, is thereafter revoked or modified by the appropriate authorities, this Agreement may be canceled by NOARK without liability for damages of any kind resulting from such cancellation. At NOARK's request, Purchaser shall provide to NOARK a Letter of Assurance and End-User Statement in a form reasonably satisfactory to NOARK.

19. Assignment.

Any assignment of this Agreement or of any rights or obligations under the Agreement without prior written consent of NOARK shall be void. IN the event that Purchaser transfers its business involving Equipment under these Terms, through a sale of stock or assets, the new owner(s), as a condition of the sale or transfer and subject to NOARK's express written consent shall be obligated by Purchaser to assume all of Purchaser's obligations under these Terms relating to the affected Equipment.

20. Resale.

If Purchaser resells any of the Equipment, the sale terms shall limit NOARK's liability to the buyer to the same extent that NOARK's liability to Purchaser is limited hereunder.

21. Entire Agreement.

This Agreement constitutes the entire agreement between NOARK and Purchaser. There are no agreements, understandings, restrictions, warranties, or representations between NOARK and Purchaser other than those set forth herein or herein provided.

22. General.

(a) This Agreement is in English. In the event this Agreement is translated into a language or languages other than English, this version in English shall be controlling on all questions of interpretation and performance.

(b) The rights and obligations under Sections 3, 5, 6, 9, 10, 12 – 14, 16, 17 shall survive the cancellation, termination or expiration of these Terms.

NOARK

📍 NOARK Electric USA
2188 Pomona Blvd.
Pomona, CA 91768
☎️ (626) 330-7007
✉️ nasales@noark-electric.com

📍 NOARK Electric Canada
975 Bleams Rd. Unit 3
Kitchener, ON N2E 3Z5
☎️ (519) 790-0605
✉️ casales@noark-electric.com

🌐 na.noark-electric.com

SNS Industrial Group



221 Holiday Inn Drive, Unit 102A
Cambridge Ontario N3C 3T2

www.snsindustrial.com
226-566-9677
Sales@snsindustrial.com

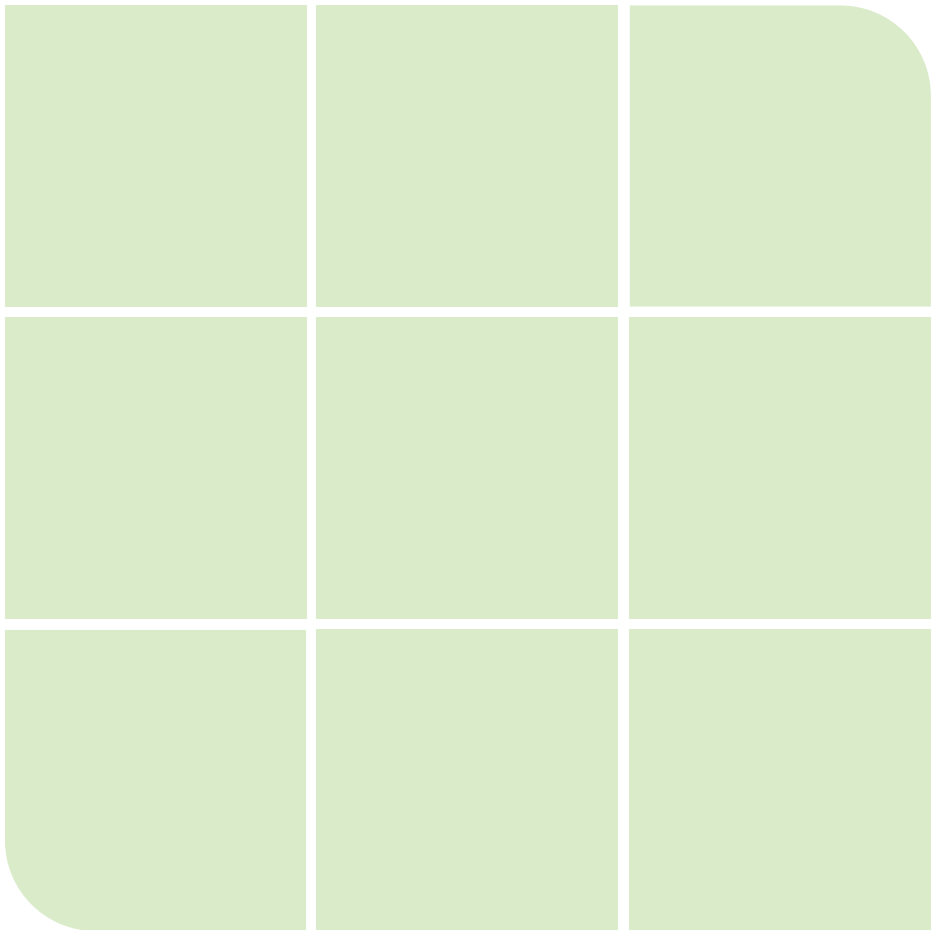

Note: NOARK Electric reserves the right to make technical changes or modify the contents of this document without prior notice. With regard to purchase orders, the agreed particulars shall prevail. NOARK Electric does not accept any responsibility whatsoever for potential errors or possible lack of information in this document. NOARK Electric reserves all rights in this document and in the subject matter and illustrations contained therein. Any reproduction, disclosure to third parties or utilization of its contents – in whole or in parts – is forbidden without prior written consent of NOARK Electric.